



leading valve technology™



valve product range

valves • certified valves • manifolds
edge valves • control valves • control valves
• high pressure valves • certified valves
special valves • cartridge valves
lateral valves • coaxial valves • certified valves
• coaxial valves • lateral valves

müller co-ax ag - the company	4
coaxial valves - the technology	8
coaxial valves	10
2/2- and 3/2-way valves	
direct actuated and externally controlled	
orifice	DN 8 - 250
pressure range	PN 0 - 100 bar
certified valves DVGW, ATEX, TÜV	21
2/2- and 3/2-way valves	
direct actuated	
orifice	DN 1,5 - 50
pressure range	PN 0 - 500 bar
cartridge valves	27
2/2-way valves	
externally controlled	
orifice	DN 10 - 15
pressure range	PN 0 - 150 bar
lateral valves	29
2/2- and 3/2-way valves	
direct actuated	
orifice	DN 12 - 50
pressure range	PN 0 - 10 bar
high pressure valves	31
2/2- and 3/2-way valves	
direct actuated and externally controlled	
orifice	DN 1,5 - 50
pressure range	PN 0 - 500 bar
manifolds & modules	41
coaxial and cartridge valves	
direct actuated and externally controlled	
orifice	DN 8 - 32
pressure range	PN 0 - 100 bar
control valves	47
pressure limitation (manual and proportional externally controlled)	
pressure reduction (manual and proportional externally controlled)	
pressure control (proportional externally controlled)	
positioning (stepping motor actuated)	
special valves	53
2/2- and 3/2-way valves	
direct actuated and externally controlled	
orifice	DN 5 - 80
pressure range	PN 0 - 500 bar





müller co-ax ag leading valve technology

When dealing with the control, regulation and monitoring of very different media, a reliable partner is required. Our innovations and know-how make us this reliable partner, as, after all, we developed the original coaxial valves. Since 1960, coaxial valves made by müller co-ax ag are used everywhere where media has to be guided in a controlled manner, where quality without compromises is required and where the highest demands are placed on systems.

Foundation of the company „Müller Steuergeräte“ by Gottfried Müller; development of the coaxial valve

1960

presentation of the coaxial valves at the Hannover Fair

1970

Approved supplier for the automotive industry

1980

Relocation to new facilities in the Forchtenberger Industrial Park

1985

changing of the company name in müller co-ax gmbh

1990

1960

1970

1980

1990





The müller co-ax ag: A company having grown from the humblest of beginnings into the epitome of valve technology within the industry. We are synonymous for innovation and individuality, for confidence and quality, for experience and reliability in valve technology. This has been the case since the beginning of our dynamic development and it will continue to stay that way. More than 50 years of experience however also means responsibility: to our company, to what we have achieved with our employees and of course to our customers.

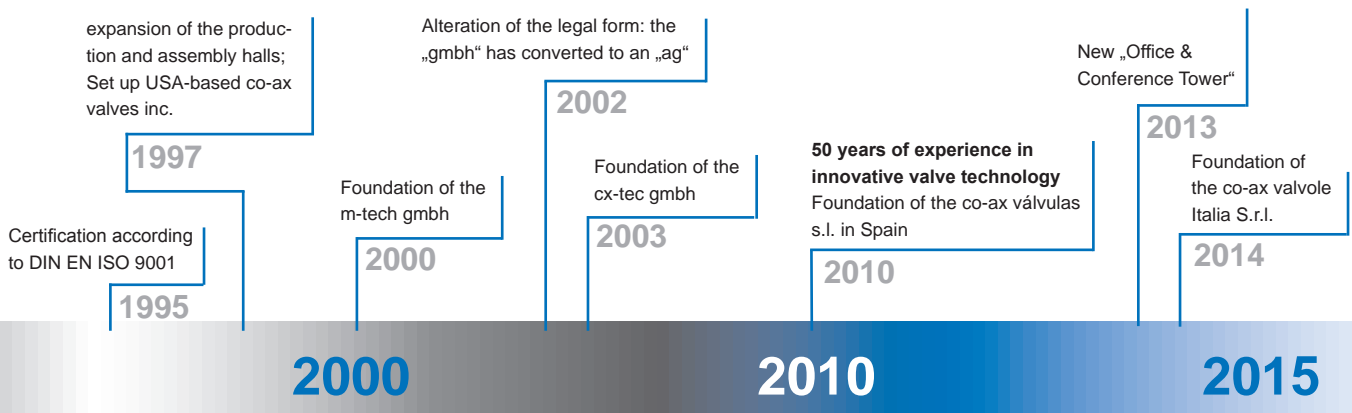

müller co-ax worldwide

The müller co-ax ag is based in Forchtenberg in Baden-Württemberg.

With subsidiaries, its own sales offices and more than 25 distributors, müller co-ax has a worldwide presence and can guarantee local and competent advice:

distributors:

Argentina • Australia • Austria • Belgium • Brazil • Bulgaria • China • Czech Republik • Denmark • Finland
France • Hungary • India • Israel • Japan • Netherlands • Norway • Poland • Portugal
Romania • Russia • Slovenia • South Africa • South Korea • Sweden • Switzerland • Taiwan • Thailand
Turkey • Ukraine • United Kingdom

subsidiaries:

m-tech gmbh in Forchtenberg, Germany

cx-tec gmbh in Forchtenberg, Germany

co-ax valves inc. in Bristol, USA

co-ax válvulas s.l. in Madrid, Spain

co-ax valvole Italia S.r.l. in Grassobbio, Italy

co-ax valves shanghai office in Shanghai, China

co-ax valves Pte Ltd in Singapore, Singapore



Our quality standards

From the product development via the selection of our raw materials, minimum tolerances in production and permanent inspections right up to the final inspections of our valves on specially constructed test stands: our entire development and production procedure fulfils the highest quality standards. This is represented by our certification acc. DIN EN ISO 9001:2008 and PED 2014/68/EU. And of course, co-ax itself is a synonym for quality and reliability.



Safety Integrity Level IEC 61508



Safety Integrity Level IEC 61508



coaxial valves - the technology

coaxial valves have formed a tried and tested element in the control of vacuums and gaseous, liquid, abrasive, highly viscous, contaminated and aggressive media.

The product diversity ranges from simple switching valves through application-specific special valves to complete modules.

Using a wide selection of orifice sizes, port connections, seal and seat configurations, our experienced application engineers tailor valves for maximum performance in a virtually unlimited range of applications.



coaxial valves offer many decisive advantages:

pressure balanced design / operating from 0 bar

The coaxial design keeps forces within the valve balanced regardless of system pressure and delta P. Whether controlling vacuum or high pressure - performance remains precise and dependable. Unlike conventional valves, coaxial valves require no minimum pressure differential in order to function.

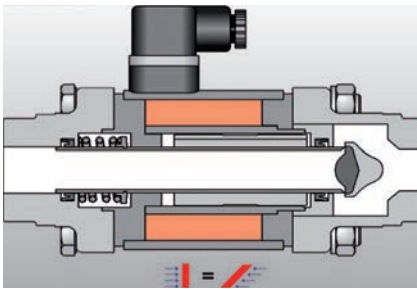

back pressure tight

When the valve is closed, the pressure at the outlet side can be higher without any leakage.

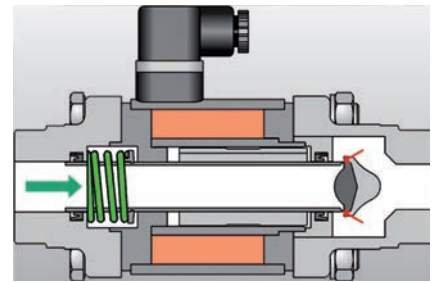

maintenance free / resistant to dirt

The unique coaxial valve design minimizes wear of the valve seat even where extremely contaminated media is involved. Due to the special design with only a single moving part, no stem seal or external actuator / operator, coaxial valves do not require any maintenance. Even under extreme conditions, coaxial valves have up to 10 times longer lifetimes than conventional valves.

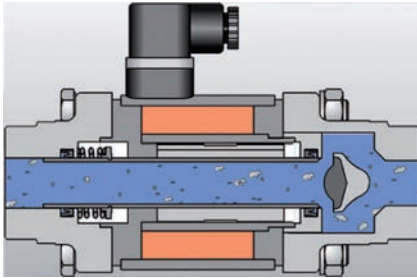

fast actuation

Pressure balanced design provides fast, repeatable operation in less than 30 milliseconds making coaxial valves some of the fastest valves you can specify.

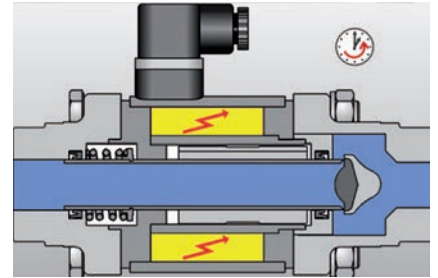

bi-directional operation

The valve design allows the medium to flow through in both directions, eliminating the need for multiple valves.

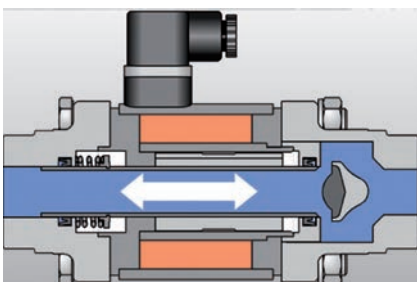

compact size

The coaxial valve design provides a compact package by eliminating bulky actuators.

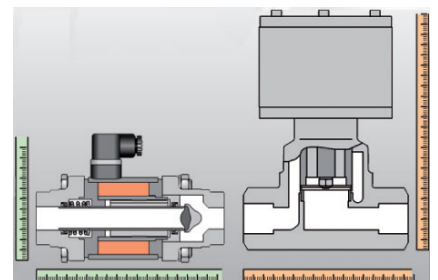

direct actuated

2/2-way coaxial valve
threaded port connection

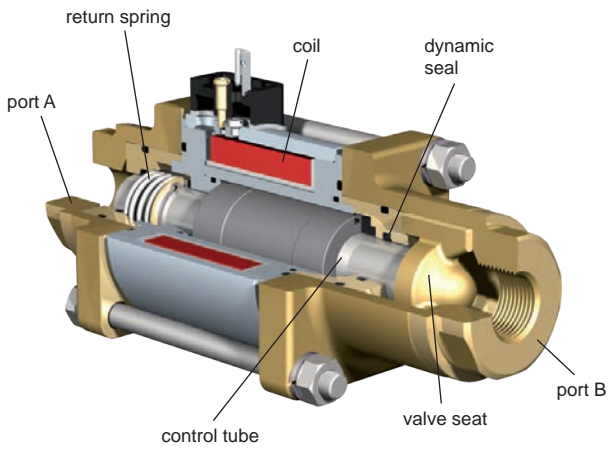

3/2-way coaxial valve
flanged port connection

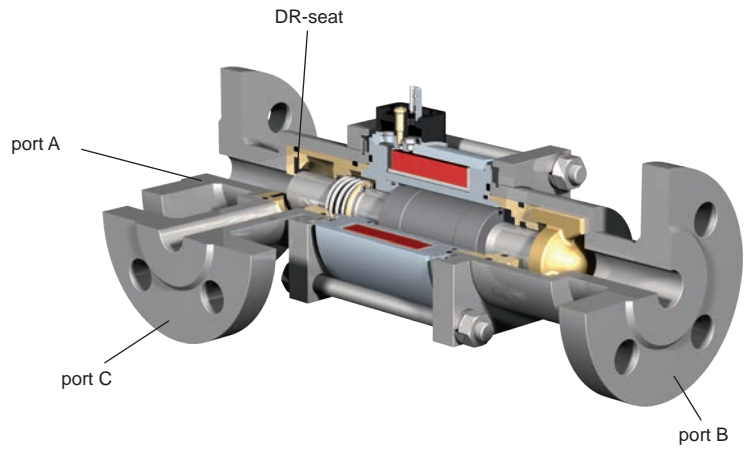

externally controlled

2/2-way coaxial valve
threaded port connection

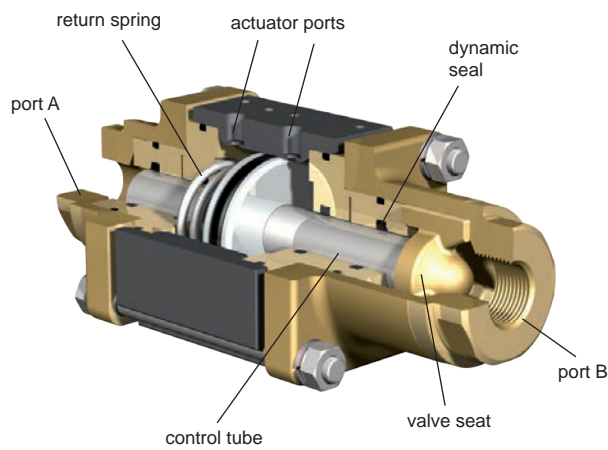

3/2-way coaxial valve
flanged port connection

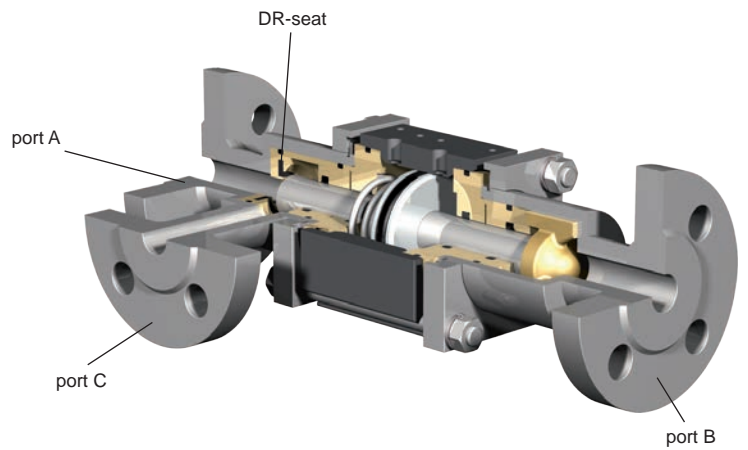

modular system

1- up to 8-station
direct actuated version

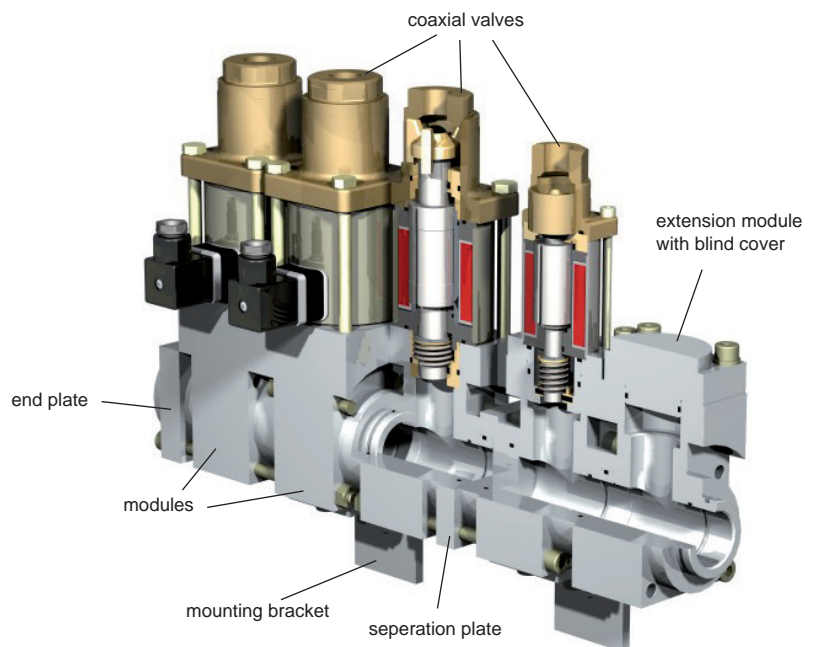

series MK / FK coaxial valves

2/2-way valve

direct actuated

orifice

DN 10 - 80

pressure range

PN 0 - 100 bar

ports

threaded / flanged

function **NC**

valve normally closed

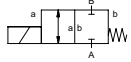

function **NO**

valve normally open

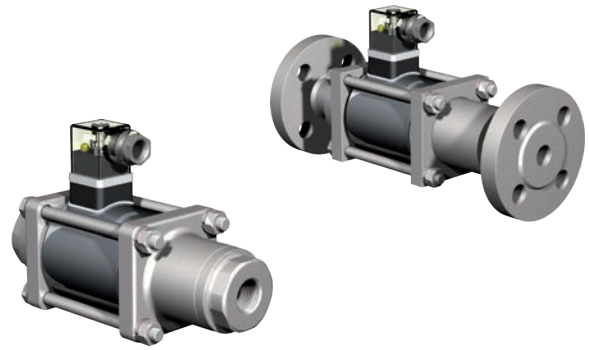
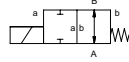

specifications

design	pressure balanced, with spring return
function	NC - normally closed
	NO - normally open
body materials	aluminium, brass, galvanized steel, nickel plated brass, nickel plated steel, without non-ferrous metals, stainless steel
seal materials	NBR, PTFE, FPM, CR, EPDM, special materials
media	gaseous, liquid, highly viscous, contaminated
actuation	DC direct-current magnet
	AC direct-current magnet, with integrated / separate rectifier
nominal voltage	DC 24 V / AC 230 V
electrical connection	plug acc. DIN EN 175301-803, form A, LED
insulation class	H - 180 °C
enclosure protection	IP 65
energized duty rating	ED 100 %
flow direction	A ⇒ B
	B ⇒ A (Δp 16 bar max.)
vacuum	leak rate < 10 ⁻⁶ mbar•l•s ⁻¹
options / accessories	special threads, special flanges, function NO, damping, limit switches, manual override, approvals, mounting,
	special voltage, connector M12x1, terminal box, ATEX zone 2 cat. 3 max 80°C

technical data

co-ax type	orifice [mm]	ports threaded	ports flanged	pressure range [bar]	Kv value A ⇒ B	media temperature	ambient temperature	switching time [ms] opening / closing
MK 10	DN 10	G 1/4 - G 3/4	-	0 - 16 / 40 / 64	2,5 m³/h	-20 °C ... +120 °C	-10 °C ... +80 °C	25 / 25
MK / FK 15	DN 15	G 3/8 - G 3/4	PN 16 / 40 / 100	0 - 16 / 40 / 64 / 100	4,8 m³/h	-20 °C ... +160 °C	-20 °C ... +80 °C	80 / 80
MK / FK 20	DN 20	G 3/4 - G 1 1/4	PN 16 / 40 / 100	0 - 16 / 40 / 64 / 100	7,4 m³/h	-20 °C ... +160 °C	-20 °C ... +80 °C	110 / 110
MK / FK 25	DN 25	G 1 - G 1 1/2	PN 16 / 40 / 100	0 - 16 / 40 / 64 / 100	11,2 m³/h	-20 °C ... +160 °C	-20 °C ... +80 °C	130 / 130
MK / FK 32	DN 32	G 1 1/4 - G 1 1/2	PN 16 / 40 / 100	0 - 16 / 40 / 64 / 100	14,1 m³/h	-20 °C ... +160 °C	-20 °C ... +80 °C	440 / 250
MK / FK 40	DN 40	G 1 1/2 - G 2	PN 16 / 40 / 100	0 - 16 / 40 / 64	18,4 m³/h	-20 °C ... +160 °C	-20 °C ... +80 °C	520 / 150
MK / FK 50	DN 50	G 2	PN 16	0 - 16	28,2 m³/h	-20 °C ... +120 °C	-20 °C ... +80 °C	400 / 400
FK 65	DN 65	-	PN 16	0 - 16	45,0 m³/h	-20 °C ... +80 °C	-20 °C ... +80 °C	600 / 800
FK 80	DN 80	-	PN 16	0 - 16	70,0 m³/h	-20 °C ... +80 °C	-20 °C ... +80 °C	600 / 800

length

co-ax type	ports	standard	1 limit switch inductive	2 limit switches inductive	1 limit switch mechanical	manual override
MK 10	thread	159,5 mm	159,5 mm	-	-	-
MK / FK 15	thread / flange	184 mm / 241 mm	224 mm / 281 mm	224 mm / 281 mm	224 mm / 281 mm	224 mm / 281 mm
MK / FK 20	thread / flange	215 mm / 269 mm	259 mm / 313 mm	259 mm / 313 mm	259 mm / 313 mm	259 mm / 313 mm
MK / FK 25	thread / flange	246 mm / 302 mm	287 mm / 343 mm	287 mm / 343 mm	287 mm / 343 mm	299 mm / 355 mm
MK / FK 32	thread / flange	258 mm / 324 mm	299 mm / 365 mm	299 mm / 365 mm	299 mm / 365 mm	299 mm / 365 mm
MK / FK 40	thread / flange	258 mm / 324 mm	299 mm / 365 mm	299 mm / 365 mm	299 mm / 365 mm	299 mm / 365 mm
MK / FK 50	thread / flange	365 mm / 438 mm	365 mm / 438 mm	365 mm / 438 mm	365 mm / 438 mm	365 mm / 438 mm
FK 65	flange	551 mm	551 mm	551 mm	-	-
FK 80	flange	573 mm	573 mm	573 mm	-	-

The valve's technical design is based on media and application requirements. This can lead to deviations from the general specifications shown on the data sheet with regards to the design, sealing materials and characteristics.

3/2-way valve
 direct actuated
 orifice DN 10 - 80
 pressure range PN 0 - 40 bar
 ports threaded / flanged

function NC
 valve normally closed

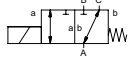

function NO
 valve normally open

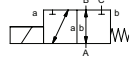

specifications

design	pressure balanced, with spring return, switching overlap
function	DR NC - normally closed (A ⇒ B) DR NO - normally open (A ⇒ B)
body materials	aluminium, brass, galvanized steel, nickel plated brass, nickel plated steel, without non-ferrous metals, stainless steel
seal materials	NBR, PTFE, FPM, CR, EPDM, special materials
media	gaseous, liquid, highly viscous, contaminated
actuation	DC direct-current magnet AC direct-current magnet, with integrated / separate rectifier
nominal voltage	DC 24 V / AC 230 V
electrical connection	plug acc. DIN EN 175301-803, form A, LED
insulation class	H - 180 °C
enclosure protection	IP 65
energized duty rating	ED 100 %
flow direction	A ⇒ B / A ⇒ C B ⇒ A (Δp 16 bar max.)
vacuum	leak rate < 10 ⁻⁶ mbar•l•s ⁻¹
options / accessories	special threads, special flanges, function NO, damping, limit switches, manual override, approvals, mounting, special voltage, connector M12x1, terminal box, ATEX zone 2 cat. 3 max 80°C



coaxial

technical data

co-ax type	orifice [mm]	ports threaded	ports flanged	pressure range [bar]	Kv value A ⇒ B	media temperature	ambient temperature	switching time [ms] opening / closing
MK 10 DR	DN 10	G 1/4 - G 3/4	-	0 - 16 / 25 / 40	2,6 m³/h	-20 °C ... +120 °C	-10 °C ... +80 °C	40 / 25
MK / FK 15 DR	DN 15	G 3/8 - G 3/4	PN 16 / 40	0 - 16 / 40	4,3 m³/h	-20 °C ... +160 °C	-20 °C ... +80 °C	80 / 80
MK / FK 20 DR	DN 20	G 3/4 - G 1 1/4	PN 16 / 40	0 - 16 / 40	6,7 m³/h	-20 °C ... +160 °C	-20 °C ... +80 °C	110 / 110
MK / FK 25 DR	DN 25	G 1 - G 1 1/2	PN 16 / 40	0 - 16 / 40	11,2 m³/h	-20 °C ... +160 °C	-20 °C ... +80 °C	130 / 130
MK / FK 32 DR	DN 32	G 1 1/4 - G 1 1/2	PN 16 / 40	0 - 16 / 40	14,1 m³/h	-20 °C ... +160 °C	-20 °C ... +80 °C	440 / 250
MK / FK 40 DR	DN 40	G 1 1/2 - G 2	PN 16	0 - 16	18,4 m³/h	-20 °C ... +160 °C	-20 °C ... +80 °C	520 / 150
MK / FK 50 DR	DN 50	G 2	PN 16	0 - 16	28,2 m³/h	-20 °C ... +120 °C	-20 °C ... +80 °C	400 / 400
FK 65 DR	DN 65	-	PN 16	0 - 16	40,0 m³/h	-20 °C ... +80 °C	-20 °C ... +80 °C	600 / 800
FK 80 DR	DN 80	-	PN 16	0 - 16	55,0 m³/h	-20 °C ... +80 °C	-20 °C ... +80 °C	600 / 800

length

co-ax type	ports	standard	1 limit switch inductive	2 limit switches inductive	1 limit switch mechanical	manual override
MK 10 DR	thread	166,5 mm	-	-	-	-
MK / FK 15 DR	thread / flange	209 mm / 265 mm	249 mm / 305 mm	249 mm / 305 mm	249 mm / 305 mm	249 mm / 305 mm
MK / FK 20 DR	thread / flange	247 mm / 301 mm	291 mm / 345 mm	291 mm / 345 mm	291 mm / 345 mm	291 mm / 345 mm
MK / FK 25 DR	thread / flange	281 mm / 337 mm	322 mm / 378 mm	322 mm / 378 mm	322 mm / 378 mm	334 mm / 390 mm
MK / FK 32 DR	thread / flange	332 mm / 394 mm	373 mm / 435 mm	373 mm / 435 mm	373 mm / 435 mm	373 mm / 435 mm
MK / FK 40 DR	thread / flange	332 mm / 394 mm	373 mm / 435 mm	373 mm / 435 mm	373 mm / 435 mm	373 mm / 435 mm
MK / FK 50 DR	thread / flange	453 mm / 553 mm	453 mm / 553 mm	453 mm / 553 mm	453 mm / 553 mm	453 mm / 553 mm
FK 65 DR	flange	586 mm	586 mm	586 mm	-	-
FK 80 DR	flange	633 mm	633 mm	633 mm	-	-

The valve's technical design is based on media and application requirements. This can lead to deviations from the general specifications shown on the data sheet with regards to the design, sealing materials and characteristics.

type RMK / RFK greenline coaxial valves

2/2-way valve

direct actuated

orifice

DN 15 - 40

pressure range

PN 0 - 100 bar

ports

threaded / flanged

function NC

valve normally closed

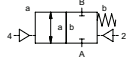

specifications

design	pressure balanced, with spring return
function	NC - normally closed
body materials	brass, galvanized steel, nickel plated brass, nickel plated steel, without non-ferrous metals, stainless steel
seal materials	NBR, PTFE, FPM, EPDM, special materials
media	gaseous, liquid, highly viscous, contaminated
actuation	DC direct-current magnet
nominal voltage	DC 24 V
electrical connection	terminal box M16x1,5 or M12x1
enclosure protection	IP 65
energized duty rating	ED 100 %
flow direction	A ⇒ B
vacuum	
version open / closed	fully automatic energy reduction in the energized position; endposition indicator open/close visual and electrical integrated; 4 selectable switching times
options / accessories	special threads, special flanges, mounting

technical data

co-ax type	orifice [mm]	ports threaded	ports flanged	pressure range [bar]	Kv value A ⇒ B	media temperature	ambient temperature	switching time [ms] opening / closing
RMK / RFK 15	DN 15	G 3/8 - G 3/4	PN 16 / 40 / 100	0 - 16 / 40 / 64 / (100)	3,9 m³/h	-20 °C ... +100 °C	-20 °C ... +80 °C	200 - 1000
RMK / RFK 20	DN 20	G 3/4 - G 1 1/4	PN 16 / 40 / 100	0 - 16 / 40 / 64 / (100)	6,9 m³/h	-20 °C ... +100 °C	-20 °C ... +80 °C	200 - 1000
RMK / RFK 25	DN 25	G 1 - G 1 1/2	PN 16 / 40 / 100	0 - 16 / 40 / 64 / (100)	11,2 m³/h	-20 °C ... +100 °C	-20 °C ... +80 °C	200 - 1000
RMK / RFK 32	DN 32	G 1 1/4 - G 1 1/2	PN 16 / 40	0 - 16 / 40 / (64)	14,1 m³/h	-20 °C ... +100 °C	-20 °C ... +80 °C	200 - 1000
RMK / RFK 40	DN 40	G 1 1/2 - G 2	PN 16 / 40	0 - 16 / 40 / (64)	18,4 m³/h	-20 °C ... +100 °C	-20 °C ... +80 °C	200 - 1000

length

co-ax type	ports	standard	1 limit switch	2 limit switches	1 limit switch mechanical	manual override
RMK / RFK 15	thread / flange	184 mm / 241 mm	-	-	-	-
RMK / RFK 20	thread / flange	215 mm / 269 mm	-	-	-	-
RMK / RFK 25	thread / flange	246 mm / 302 mm	-	-	-	-
RMK / RFK 32	thread / flange	258 mm / 324 mm	-	-	-	-
RMK / RFK 40	thread / flange	258 mm / 324 mm	-	-	-	-

2/2-way valve
externally controlled
orifice
pressure range
ports

DN 8
PN 0 - 40 bar
threaded

function **NC**
valve normally closed

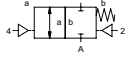

function **NO**
valve normally open

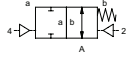

specifications

design	pressure balanced, with spring return
function	NC - normally closed NO - normally open
body materials	brass, stainless steel
seal materials	NBR, FPM, PE, PU, PTFE
media	emulsions, oils, neutral gases
actuation	pneumatic actuation via 3/2-way pilot valve
pilot valve interface	co-ax
nominal voltage	DC 24 V / AC 230 V
electrical connection pilot valve	plug acc. DIN EN 175301-803 form B, LED
enclosure protection	IP 65
energized duty rating	ED 100 %
flow direction	A ⇌ B B ⇌ A (without actuation pressure Δp 16 bar max.)
vacuum	leak rate < 10^{-6} mbar•s ⁻¹
options / accessories	function NO, limit switches, manual override, mounting, special voltage, connector M12x1, explosion proof ATEX zone 1 and 2 cat. 3, pilot valve



coaxial

technical data

co-ax type	orifice [mm]	ports threaded	ports flanged	pressure range [bar]	Kv value A ⇌ B	media temperature	ambient temperature	switching time [ms] opening / closing
CFM 08	DN 8	G 3/8	-	0 - 40	1,6 m ³ /h	-20 °C ... +60 °C	-20 °C ... +60 °C	70 / 80

length

co-ax type	ports	standard	1 limit switch	2 limit switches	1 limit switch mechanical	manual override
CFM 08	thread	80 mm	80 mm	80 mm	-	via pilot valve

The valve's technical design is based on media and application requirements. This can lead to deviations from the general specifications shown on the data sheet with regards to the design, sealing materials and characteristics.

type MCF coaxial valves

2/2-way valve

externally controlled

orifice

DN 8

pressure range

PN 0 - 100 bar

ports

threaded

function **NC**

valve normally closed

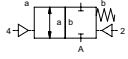

function **NO**

valve normally open

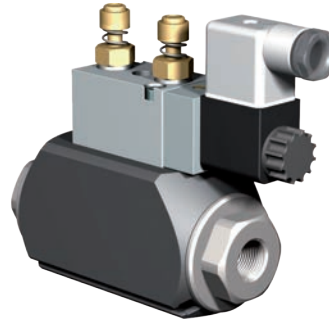
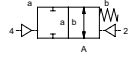

specifications

design	pressure balanced, with spring return
function	NC - normally closed NO - normally open
body materials	brass
seal materials	NBR, FPM, PTFE
media	emulsions, oils, neutral gases
actuation	pneumatic actuation via 5/2-way pilot valve
pilot valve interface	co-ax
nominal voltage	DC 24 V / AC 230 V
electrical connection pilot valve	plug acc. DIN EN 175301-803 form B, LED
enclosure protection	IP 65
energized duty rating	ED 100 %
flow direction	A ⇌ B B ⇌ A (without actuation pressure Δp 16 bar max.)
vacuum	leak rate < 10 ⁻⁶ mbar•l•s ⁻¹
options / accessories	function NO, damping, limit switches, manual override, mounting, special voltage, connector M12x1, explosion proof ATEX zone 1 and 2 cat. 3, pilot valve

technical data

co-ax type	orifice [mm]	ports threaded	ports flanged	pressure range [bar]	Kv value A ⇌ B	media temperature	ambient temperature	switching time [ms] opening / closing
MCF 08	DN 8	G 3/8	-	0 - 100	1,6 m³/h	-20 °C ... +160 °C	-20 °C ... +160 °C	30-3000 / 30-3000

length

co-ax type	ports	standard	1 limit switch	2 limit switches	1 limit switch mechanical	manual override
MCF 08	thread	120 mm	120 mm	120 mm	-	via pilot valve

The valve's technical design is based on media and application requirements. This can lead to deviations from the general specifications shown on the data sheet with regards to the design, sealing materials and characteristics.

2/2-way valve

externally controlled

orifice

DN 10 - 50

pressure range

PN 0 - 100 bar

ports

threaded / flanged

function NC

valve normally closed

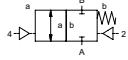

function NO

valve normally open

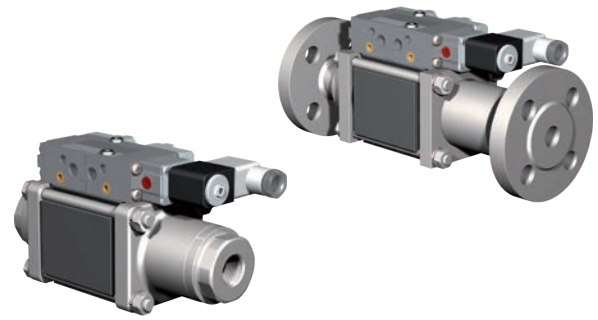
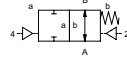

specifications

design	pressure balanced, with spring return
function	NC - normally closed
	NO - normally open
body materials	brass, galvanized steel, nickel plated brass, nickel plated steel, without non-ferrous metals, stainless steel
seal materials	NBR, PTFE, FPM, CR, EPDM, special materials
media	gaseous, liquid, highly viscous, contaminated
actuation	pneumatic actuation via 5/2-way pilot valve, hydraulic actuation via 4/2-way control valve
pilot valve interface	NAMUR / ISO 1
nominal voltage	DC 24 V / AC 230 V
electrical connection pilot valve	plug acc. DIN EN 175301-803 form B, LED
enclosure protection	IP 65
energized duty rating	ED 100 %
flow direction	A ⇒ B
	B ⇒ A (without actuation pressure Δp 16 bar max.)
vacuum	leak rate < 10 ⁻⁶ mbar•l•s ⁻¹
options / accessories	special threads, special flanges, function NO, flush ports, leak ports, limit switches, manual override, approvals, mounting, special voltage, connector M12x1, explosion proof ATEX zone 1 and 2 cat. 3, pilot valve



coaxial

technical data

co-ax type	orifice [mm]	ports threaded	ports flanged	pressure range [bar]	Kv value A ⇒ B	media temperature	ambient temperature	switching time [ms] opening / closing
VMK 10	DN 10	G 1/4 - G 3/4	-	0 - 16 / 40 / 64 / 100	2,5 m³/h	-20 °C ... +160 °C	-20 °C ... +160 °C	30-3000 / 50-3000
VMK / VFK 15	DN 15	G 3/8 - G 3/4	PN 16 / 40 / 100	0 - 16 / 40 / 64 / 100	5,7 m³/h	-20 °C ... +160 °C	-20 °C ... +160 °C	50-3000 / 50-3000
VMK / VFK 20	DN 20	G 3/4 - G 1 1/4	PN 16 / 40 / 100	0 - 16 / 40 / 64 / 100	8,8 m³/h	-20 °C ... +160 °C	-20 °C ... +160 °C	50-3000 / 50-3000
VMK / VFK 25	DN 25	G 1 - G 1 1/2	PN 16 / 40 / 100	0 - 16 / 40 / 64 / 100	13,3 m³/h	-20 °C ... +160 °C	-20 °C ... +160 °C	50-3000 / 50-3000
VMK / VFK 32	DN 32	G 1 1/4 - G 1 1/2	PN 16 / 40 / 100	0 - 16 / 40 / 64 / 100	20,0 m³/h	-20 °C ... +160 °C	-20 °C ... +160 °C	100-3000 / 100-3000
VMK / VFK 40	DN 40	G 1 1/2 - G 2	PN 100	0 - 64 / 100	31,0 m³/h	-20 °C ... +160 °C	-20 °C ... +160 °C	100-3000 / 100-3000
VMK / VFK 50	DN 50	G 2	PN 64 / 100	0 - 64 / 100	43,0 m³/h	-20 °C ... +160 °C	-20 °C ... +160 °C	150-3000 / 150-3000

length

co-ax type	ports	standard	1 limit switch inductive	2 limit switches inductive	1 limit switch mechanical	manual override
VMK 10	thread	159,5 mm	179,5 mm	179,5 mm	-	via pilot valve
VMK / VFK 15	thread / flange	186 mm / 243 mm	212 mm / 269 mm	212 mm / 269 mm	212 mm / 269 mm	via pilot valve
VMK / VFK 20	thread / flange	216 mm / 270 mm	235 mm / 289 mm	235 mm / 289 mm	250 mm / 304 mm	via pilot valve
VMK / VFK 25	thread / flange	246 mm / 302 mm	260 mm / 316 mm	260 mm / 316 mm	270 mm / 326 mm	via pilot valve
VMK / VFK 32	thread / flange	269 mm / 325 mm	276 mm / 332 mm	276 mm / 332 mm	304 mm / 360 mm	via pilot valve
VMK / VFK 40	thread / flange	312 mm / 385 mm	312 mm / 385 mm	312 mm / 385 mm	-	via pilot valve
VMK / VFK 50	thread / flange	312 mm / 385 mm	312 mm / 385 mm	312 mm / 385 mm	-	via pilot valve

The valve's technical design is based on media and application requirements. This can lead to deviations from the general specifications shown on the data sheet with regards to the design, sealing materials and characteristics.

series VMK / VFK DR coaxial valves

3/2-way valve

externally controlled

orifice

DN 10 - 50

pressure range

PN 0 - 100 bar

ports

threaded / flanged

function **NC**

valve normally closed

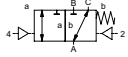

function **NO**

valve normally open

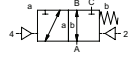

specifications

design	pressure balanced, with spring return, switching overlap
function	DR NC - normally closed (A ⇒ B) DR NO - normally open (A ⇒ B)
body materials	brass, galvanized steel, nickel plated brass, nickel plated steel, without non-ferrous metals, stainless steel
seal materials	NBR, PTFE, FPM, CR, EPDM, special materials
media	gaseous, liquid, highly viscous, contaminated
actuation	pneumatic actuation via 5/2-way pilot valve, hydraulic actuation via 4/2-way control valve
pilot valve interface	NAMUR / ISO 1
nominal voltage	DC 24 V / AC 230 V
electrical connection pilot valve	plug acc. DIN EN 175301-803 form B, LED
enclosure protection	IP 65
energized duty rating	ED 100 %
flow direction	A ⇒ B / A ⇒ C B ⇒ A (without actuation pressure Δp 16 bar max.)
vacuum	leak rate < 10 ⁻⁶ mbar•l•s ⁻¹
options / accessories	special threads, special flanges, function NO, flush ports, leak ports, limit switches, manual override, approvals, mounting, special voltage, connector M12x1, explosion proof ATEX zone 1 and 2 cat. 3, pilot valve

technical data

co-ax type	orifice [mm]	ports threaded	ports flanged	pressure range [bar]	Kv value A ⇒ B	media temperature	ambient temperature	switching time [ms] opening / closing
VMK 10 DR	DN 10	G 1/4 - G 3/4	-	0 - 16 / 40 / 64	2,5 m³/h	-20 °C ... +160 °C	-20 °C ... +160 °C	30-3000 / 50-3000
VMK / VFK 15 DR	DN 15	G 3/8 - G 3/4	PN 16 / 40 / 100	0 - 16 / 40 / 64 / 100	5,6 m³/h	-20 °C ... +160 °C	-20 °C ... +160 °C	50-3000 / 50-3000
VMK / VFK 20 DR	DN 20	G 3/4 - G 1 1/4	PN 16 / 40 / 100	0 - 16 / 40 / 64 / 100	8,3 m³/h	-20 °C ... +160 °C	-20 °C ... +160 °C	50-3000 / 50-3000
VMK / VFK 25 DR	DN 25	G 1 - G 1 1/2	PN 16 / 40 / 100	0 - 16 / 40 / 64 / 100	13,3 m³/h	-20 °C ... +160 °C	-20 °C ... +160 °C	50-3000 / 50-3000
VMK / VFK 32 DR	DN 32	G 1 1/4 - G 1 1/2	PN 16 / 40 / 100	0 - 16 / 40 / 64 / 100	18,9 m³/h	-20 °C ... +160 °C	-20 °C ... +160 °C	100-3000 / 100-3000
VMK / VFK 40 DR	DN 40	G 1 1/2 - G 2	PN 100	0 - 64 / 100	31,0 m³/h	-20 °C ... +160 °C	-20 °C ... +160 °C	100-3000 / 100-3000
VMK / VFK 50 DR	DN 50	G 2	PN 64 / 100	0 - 64 / 100	43,0 m³/h	-20 °C ... +160 °C	-20 °C ... +160 °C	150-3000 / 150-3000

length

co-ax type	ports	standard	1 limit switch inductive	2 limit switches inductive	1 limit switch mechanical	manual override
VMK 10 DR	thread	166,5 mm	186,5 mm	186,5 mm	-	via pilot valve
VMK / VFK 15 DR	thread / flange	211 mm / 267 mm	237 mm / 293 mm	237 mm / 293 mm	237 mm / 293 mm	via pilot valve
VMK / VFK 20 DR	thread / flange	248 mm / 302 mm	267 mm / 321 mm	267 mm / 321 mm	282 mm / 336 mm	via pilot valve
VMK / VFK 25 DR	thread / flange	281 mm / 337 mm	295 mm / 351 mm	295 mm / 351 mm	305 mm / 361 mm	via pilot valve
VMK / VFK 32 DR	thread / flange	304 mm / 365 mm	311 mm / 372 mm	311 mm / 372 mm	339 mm / 400 mm	via pilot valve
VMK / VFK 40 DR	thread / flange	400 mm / 500 mm	400 mm / 500 mm	400 mm / 500 mm	-	via pilot valve
VMK / VFK 50 DR	thread / flange	400 mm / 500 mm	400 mm / 500 mm	400 mm / 500 mm	-	via pilot valve

2/2-way valve

externally controlled

orifice

DN 40 - 250

pressure range

PN 0 - 40 bar

ports

threaded / flanged

function NC

valve normally closed

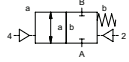

function NO

valve normally open

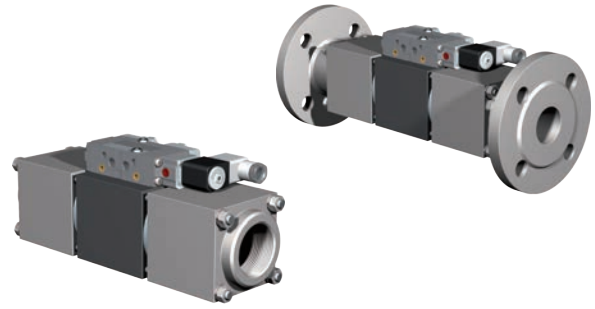
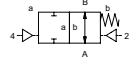

specifications

design	pressure balanced, with spring return
function	NC - normally closed
	NO - normally open
body materials	aluminium, galvanized steel, nickel plated steel, without non-ferrous metals, stainless steel
seal materials	NBR, PTFE, FPM, CR, EPDM, special materials
media	gaseous, liquid, highly viscous, contaminated
actuation	pneumatic actuation via 5/2-way pilot valve, hydraulic actuation via 4/2-way control valve
pilot valve interface	NAMUR / ISO 1
nominal voltage	DC 24 V / AC 230 V
electrical connection pilot valve	plug acc. DIN EN 175301-803 form B, LED
enclosure protection	IP 65
energized duty rating	ED 100 %
flow direction	A ⇒ B / A ⇒ C
	B ⇒ A (without actuation pressure Δp 16 bar max.)
vacuum	leak rate < 10 ⁻⁶ mbar•l•s ⁻¹
options / accessories	special threads, special flanges, function NO, flush ports, leak ports, limit switches, manual override, approvals, mounting, special voltage, connector M12x1, explosion proof ATEX zone 1 and 2 cat. 3, pilot valve



coaxial

technical data

co-ax type	orifice [mm]	ports threaded	ports flanged	pressure range [bar]	Kv value A ⇒ B	media temperature	ambient temperature	switching time [ms] opening / closing
VSV-M / VSV-F 40	DN 40	G 1 1/2 - G 2	PN 16 / 40	0 - 16 / 40	31,0 m³/h	-20 °C ... +160 °C	-20 °C ... +160 °C	100-3000 / 100-3000
VSV-M / VSV-F 50	DN 50	G 2	PN 16 / 40	0 - 16 / 40	43,0 m³/h	-20 °C ... +160 °C	-20 °C ... +160 °C	150-3000 / 150-3000
VSV-F 65	DN 65	-	PN 16 / 40	0 - 16 / 40	68,0 m³/h	-20 °C ... +160 °C	-20 °C ... +160 °C	200-3000 / 200-3000
VSV-F 80	DN 80	-	PN 16 / 40	0 - 16 / 40	90,0 m³/h	-20 °C ... +160 °C	-20 °C ... +160 °C	200-3000 / 200-3000
VSV-F 100	DN 100	-	PN 16 / 40	0 - 16 / 40	140,0 m³/h	-20 °C ... +160 °C	-20 °C ... +160 °C	300-3000 / 300-3000
VSV-F 125	DN 125	-	PN 16 / 40	0 - 16 / 40	198,0 m³/h	-20 °C ... +160 °C	-20 °C ... +160 °C	400-3000 / 400-3000
VSV-F 150	DN 150	-	PN 16 / 40	0 - 16 / 40	274,0 m³/h	-20 °C ... +160 °C	-20 °C ... +160 °C	600-3000 / 600-3000
VSV-F 200	DN 200	-	PN 16	0 - 16	450,0 m³/h	-20 °C ... +160 °C	-20 °C ... +160 °C	800-3000 / 800-3000
VSV-F 250	DN 250	-	PN 16	0 - 16	650,0 m³/h	-20 °C ... +160 °C	-20 °C ... +160 °C	1500-3000 / 1500-3000

length

co-ax type	ports	standard	1 limit switch inductive	2 limit switches inductive	1 limit switch mechanical	manual override
VSV-M / VSV-F 40	thread / flange	277 mm / 363 mm	312 mm / 417 mm	312 mm / 417 mm	304 mm / 390 mm	via pilot valve
VSV-M / VSV-F 50	thread / flange	304 mm / 404 mm	330 mm / 430 mm	330 mm / 430 mm	344 mm / 444 mm	via pilot valve
VSV-F 65	flange	538 mm	538 mm	538 mm	-	via pilot valve
VSV-F 80	flange	580 mm	580 mm	580 mm	-	via pilot valve
VSV-F 100	flange	600 mm	600 mm	600 mm	-	via pilot valve
VSV-F 125	flange	697 mm	697 mm	697 mm	-	via pilot valve
VSV-F 150	flange	771 mm	771 mm	771 mm	-	via pilot valve
VSV-F 200	flange	925 mm	925 mm	925 mm	-	via pilot valve
VSV-F 250	flange	1035 mm	1035 mm	1035 mm	-	via pilot valve

The valve's technical design is based on media and application requirements. This can lead to deviations from the general specifications shown on the data sheet with regards to the design, sealing materials and characteristics.

series VSV-M / VSV-F DR coaxial valves

3/2-way valve

externally controlled

orifice

DN 40 - 150

pressure range

PN 0 - 40 bar

ports

threaded / flanged

function **NC**

valve normally closed

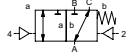

function **NO**

valve normally open

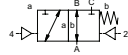

specifications

design	pressure balanced, with spring return, switching overlap
function	DR NC - normally closed (A ⇒ B) DR NO - normally open (A ⇒ B)
body materials	aluminium, galvanized steel, nickel plated steel, without non-ferrous metals, stainless steel
seal materials	NBR, PTFE, FPM, CR, EPDM, special materials
media	gaseous, liquid, highly viscous, contaminated
actuation	pneumatic actuation via 5/2-way pilot valve, hydraulic actuation via 4/2-way control valve
pilot valve interface	NAMUR / ISO 1
nominal voltage	DC 24 V / AC 230 V
electrical connection pilot valve	plug acc. DIN EN 175301-803 form B, LED
enclosure protection	IP 65
energized duty rating	ED 100 %
flow direction	A ⇒ B / A ⇒ C B ⇒ A (without actuation pressure Δp 16 bar max.)
vacuum	leak rate < 10 ⁻⁶ mbar•l•s ⁻¹
options / accessories	special threads, special flanges, function NO, flush ports, leak ports, limit switches, manual override, approvals, mounting, special voltage, connector M12x1, explosion proof ATEX zone 1 and 2 cat. 3, pilot valve

technical data

co-ax type	orifice [mm]	ports threaded	ports flanged	pressure range [bar]	Kv value A ⇒ B	media temperature	ambient temperature	switching time [ms] opening / closing
VSV-M / VSV-F 40 DR	DN 40	G 1 1/2 - G 2	PN 16 / 40	0 - 16 / 40	29,1 m³/h	-20 °C ... +160 °C	-20 °C ... +160 °C	100-3000 / 100-3000
VSV-M / VSV-F 50 DR	DN 50	G 2	PN 16 / 40	0 - 16 / 40	43,0 m³/h	-20 °C ... +160 °C	-20 °C ... +160 °C	150-3000 / 150-3000
VSV-F 65 DR	DN 65	-	PN 16 / 40	0 - 16 / 40	68,0 m³/h	-20 °C ... +160 °C	-20 °C ... +160 °C	200-3000 / 200-3000
VSV-F 80 DR	DN 80	-	PN 16 / 40	0 - 16 / 40	90,0 m³/h	-20 °C ... +160 °C	-20 °C ... +160 °C	250-3000 / 250-3000
VSV-F 100 DR	DN 100	-	PN 16 / 40	0 - 16 / 40	140,0 m³/h	-20 °C ... +160 °C	-20 °C ... +160 °C	300-3000 / 300-3000
VSV-F 125 DR	DN 125	-	PN 16	0 - 16	198,0 m³/h	-20 °C ... +160 °C	-20 °C ... +160 °C	400-3000 / 400-3000
VSV-F 150 DR	DN 150	-	PN 16	0 - 16	274,0 m³/h	-20 °C ... +160 °C	-20 °C ... +160 °C	600-3000 / 600-3000

length

co-ax type	ports	standard	1 limit switch inductive	2 limit switches inductive	1 limit switch mechanical	manual override
VSV-M / VSV-F 40 DR	thread / flange	291 mm / 377 mm	338 mm / 424 mm	338 mm / 424 mm	-	via pilot valve
VSV-M / VSV-F 50 DR	thread / flange	328 mm / 428 mm	354 mm / 454 mm	354 mm / 454 mm	-	via pilot valve
VSV-F 65 DR	flange	573 mm	573 mm	573 mm	-	via pilot valve
VSV-F 80 DR	flange	640 mm	640 mm	640 mm	-	via pilot valve
VSV-F 100 DR	flange	673 mm	673 mm	673 mm	-	via pilot valve
VSV-F 125 DR	flange	790 mm	790 mm	790 mm	-	via pilot valve
VSV-F 150 DR	flange	889 mm	889 mm	889 mm	-	via pilot valve

The valve's technical design is based on media and application requirements. This can lead to deviations from the general specifications shown on the data sheet with regards to the design, sealing materials and characteristics.

2/2-way valve

externally controlled

orifice

DN 65 - 125

pressure range

PN 0 - 40 bar

ports

flanged

function NC

valve normally closed

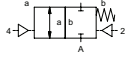

specifications

design	pressure balanced, with spring return
function	NC - normally closed
body materials	aluminium / aluminium hardcoated
seal materials	NBR, PU, PTFE, FPM, PE, special materials
media	emulsions, oils, neutral gases
actuation	pneumatic actuation via 5/2-way pilot valve, hydraulic actuation via 4/2-way control valve
pilot valve interface	NAMUR / ISO 1
nominal voltage	DC 24 V / AC 230 V
electrical connection pilot valve	plug acc. DIN EN 175301-803 form B, LED
enclosure protection	IP 65
energized duty rating	ED 100 %
flow direction	A ⇒ B B ⇒ A (without actuation pressure Δp 16 bar max.)
vacuum	leak rate < 10 ⁻⁴ mbar•l•s ⁻¹
options / accessories	manual override, approvals, sensor / manometer connection, special voltage, connector M12x1, explosion proof ATEX zone 1 and 2 cat. 3, pilot valve



coaxial

technical data

co-ax type	orifice [mm]	ports threaded	ports flanged	pressure range [bar]	Kv value A ⇒ B	media temperature	ambient temperature	switching time [ms] opening / closing
FCF-K 65	DN 65	-	PN 16 / 40	0 - 16 / 40	98,0 m³/h	-20 °C ... +160 °C	-20 °C ... +160 °C	250-3000 / 400-3000
FCF-K 80	DN 80	-	PN 16 / 40	0 - 16 / 40	122,0 m³/h	-20 °C ... +160 °C	-20 °C ... +160 °C	350-3000 / 350-3000
FCF-K 100	DN 100	-	PN 16 / 40	0 - 16 / 40	193,0 m³/h	-20 °C ... +160 °C	-20 °C ... +160 °C	450-3000 / 300-3000
FCF-K 125	DN 125	-	PN 16 / 40	0 - 16 / 40	221,0 m³/h	-20 °C ... +160 °C	-20 °C ... +160 °C	700-3000 / 450-3000

length

co-ax type	ports	standard	1 limit switch inductive	2 limit switches inductive	1 limit switch mechanical	manual override
FCF-K 65	flange	170 mm	-	-	-	via pilot valve
FCF-K 80	flange	180 mm	-	-	-	via pilot valve
FCF-K 100	flange	240 mm	-	-	-	via pilot valve
FCF-K 125	flange	300 mm	-	-	-	via pilot valve

The valve's technical design is based on media and application requirements. This can lead to deviations from the general specifications shown on the data sheet with regards to the design, sealing materials and characteristics.

series FCF coaxial valves

2/2-way valve

externally controlled

orifice

DN 65 - 125

pressure range

PN 0 - 40 bar

ports

flanged

function **NC**

valve normally closed

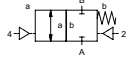

function **NO**

valve normally open

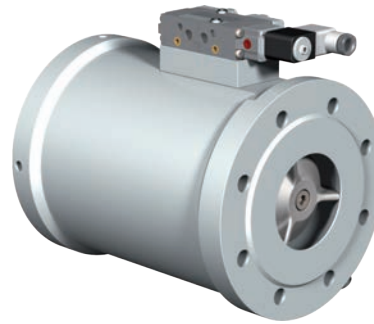
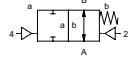

specifications

design	pressure balanced, with spring return
function	NC - normally closed
	NO - normally open
body materials	aluminium / aluminium hardcoated
seal materials	NBR, PU, PTFE, FPM, PE, special materials
media	emulsions, oils, neutral gases
actuation	pneumatic actuation via 5/2-way pilot valve, hydraulic actuation via 4/2-way control valve
pilot valve interface	NAMUR / ISO 1
nominal voltage	DC 24 V / AC 230 V
electrical connection pilot valve	plug acc. DIN EN 175301-803 form B, LED
enclosure protection	IP 65
energized duty rating	ED 100 %
flow direction	A ⇒ B
	B ⇒ A (without actuation pressure Δp 16 bar max.)
vacuum	leak rate < 10^{-4} mbar•l•s ⁻¹
options / accessories	function NO, limit switches, manual override, approvals, sensor / manometer connection, special voltage, connector M12x1, explosion proof ATEX zone 1 and 2 cat. 3, pilot valve

technical data

co-ax type	orifice [mm]	ports threaded	ports flanged	pressure range [bar]	Kv value A ⇒ B	media temperature	ambient temperature	switching time [ms] opening / closing
FCF 65	DN 65	-	PN 16 / 40	0 - 16 / 40	107,0 m³/h	-20 °C ... +160 °C	-20 °C ... +160 °C	250-3000 / 400-3000
FCF 80	DN 80	-	PN 16 / 40	0 - 16 / 40	133,0 m³/h	-20 °C ... +160 °C	-20 °C ... +160 °C	350-3000 / 350-3000
FCF 100	DN 100	-	PN 16 / 40	0 - 16 / 40	215,0 m³/h	-20 °C ... +160 °C	-20 °C ... +160 °C	450-3000 / 300-3000
FCF 125	DN 125	-	PN 16 / 40	0 - 16 / 40	227,0 m³/h	-20 °C ... +160 °C	-20 °C ... +160 °C	700-3000 / 450-3000

length

co-ax type	ports	standard	1 limit switch inductive	2 limit switches inductive	1 limit switch mechanical	manual override
FCF 65	flange	240 mm	240 mm	240 mm	-	via pilot valve
FCF 80	flange	260 mm	260 mm	260 mm	-	via pilot valve
FCF 100	flange	350 mm	350 mm	350 mm	-	via pilot valve
FCF 125	flange	400 mm	400 mm	400 mm	-	via pilot valve

2/2-way valve
 direct actuated
 orifice DN 15 - 25
 pressure range PN 0 - 40 bar
 ports threaded / flanged

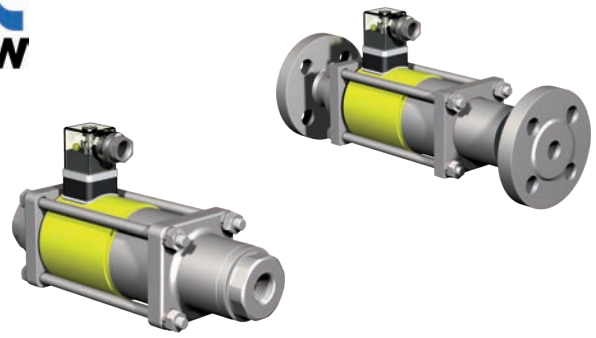

function NC
 valve normally closed

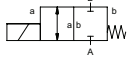

specifications

test designation	DIN DVGW acc. DIN 3394 part 1 DVGW-Ex - G 260/I
design	pressure balanced, with spring return
function	NC - normally closed
body materials	nickel plated steel
seal materials	PTFE, FPM, special materials
media	combustible gases acc. G260
actuation	DC direct-current magnet AC direct-current magnet, with integrated / separate rectifier
nominal voltage	DC 24 V / AC 230 V
electrical connection	plug acc. DIN EN 175301-803, form A, LED / M16x1,5 terminal box
insulation class	H - 180 °C
enclosure protection	IP 65
energized duty rating	ED 100 %
flow direction	A ⇒ B B ⇒ A (Δp 16 bar max.)
options / accessories	limit switches, manual override, approvals, mounting, special voltage, terminal box, explosion proof, circuit amplifier



certified

technical data

co-ax type	orifice [mm]	ports threaded	ports flanged	pressure range [bar]	Kv value A ⇒ B	media temperature	ambient temperature	switching time [ms] opening / closing
MK / FK 15 DVGW	DN 15	G 3/8 - G 3/4	PN 40	0 - 40	4,8 m³/h	-15 °C ... +80 °C	-15 °C ... +80 °C	80 / 80
MK / FK 15 DVGW Ex	DN 15	G 3/8 - G 3/4	PN 40	0 - 16	4,8 m³/h	-15 °C ... +40 °C	-15 °C ... +40 °C	80 / 80
MK / FK 20 DVGW	DN 20	G 3/4 - G 1 1/4	PN 40	0 - 40	7,4 m³/h	-15 °C ... +80 °C	-15 °C ... +80 °C	110 / 110
MK / FK 20 DVGW Ex	DN 20	G 3/4 - G 1 1/4	PN 40	0 - 16	7,4 m³/h	-15 °C ... +40 °C	-15 °C ... +40 °C	110 / 110
MK / FK 25 DVGW	DN 25	G 1 - G 1 1/2	PN 40	0 - 40	11,2 m³/h	-15 °C ... +80 °C	-15 °C ... +80 °C	130 / 130
MK / FK 25 DVGW Ex	DN 25	G 1 - G 1 1/2	PN 40	0 - 16	11,2 m³/h	-15 °C ... +40 °C	-15 °C ... +40 °C	130 / 130
MK / FK 25 DVGW Ex HT	DN 25	G 1 - G 1 1/2	PN 40	0 - 16	11,2 m³/h	-15 °C ... +70 °C	-15 °C ... +70 °C	130 / 130

length

co-ax type	ports	standard	1 limit switch inductive	2 limit switches inductive	1 limit switch mechanical	manual override
MK / FK 15 DVGW	thread / flange	224 mm / 281 mm	224 mm / 281 mm	224 mm / 281 mm	-	224 mm / 281 mm
MK / FK 15 DVGW Ex	thread / flange	234 mm / 291 mm	234 mm / 291 mm	234 mm / 291 mm	-	224 mm / 281 mm
MK / FK 20 DVGW	thread / flange	259 mm / 313 mm	259 mm / 313 mm	259 mm / 313 mm	-	259 mm / 313 mm
MK / FK 20 DVGW Ex	thread / flange	259 mm / 313 mm	259 mm / 313 mm	259 mm / 313 mm	-	259 mm / 313 mm
MK / FK 25 DVGW	thread / flange	299 mm / 355 mm	299 mm / 355 mm	299 mm / 355 mm	-	299 mm / 355 mm
MK / FK 25 DVGW Ex	thread / flange	299 mm / 355 mm	299 mm / 355 mm	299 mm / 355 mm	-	299 mm / 355 mm

The valve's technical design is based on media and application requirements. This can lead to deviations from the general specifications shown on the data sheet with regards to the design, sealing materials and characteristics.

type KBS Ex certified valves

2/2-way valve
 direct actuated
 orifice
 pressure range
 ports

DN 1,5 - 3
 PN 0 - 500 bar
 threaded

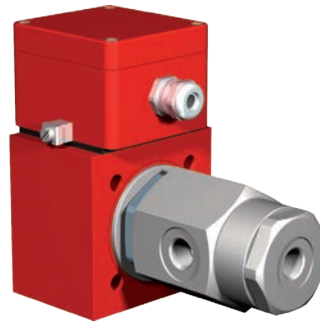

function **NC**
 valve normally closed

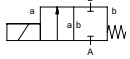

function **NO**
 valve normally open

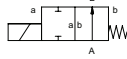

specifications

ex-protective classes	II 2 G Eex me II T4 and II 2 D IP 65 T 130°C PTB 02 ATEX 2120 x
design	direct acting, with spring return
function	NC - normally closed NO - normally open
body materials	brass, nickel plated brass, stainless steel
seal materials	NBR, FPM, special materials
media	gaseous, liquid
actuation	DC direct-current magnet AC direct-current magnet, with integrated / separate rectifier
nominal voltage	DC 24 V / AC 230 V
electrical connection	M16x1,5 terminal box
insulation class	H - 180 °C
enclosure protection	IP 65
energized duty rating	ED 100 %
flow direction	A ⇒ B
vacuum	leak rate < 10 ⁻⁶ mbar•l•s ⁻¹
options / accessories	special threads, function NO, approvals, mounting, special voltage

technical data

co-ax type	orifice [mm]	ports threaded	ports flanged	pressure range [bar]	Kv value A ⇒ B	media temperature	ambient temperature	switching time [ms] opening / closing
KBS 15 Ex	DN 1,5	G 3/8	-	0 - 150 / 500 (NO)	1,1 l/min	-20 °C ... +40 °C	-20 °C ... +40 °C	250 / 160
KBS 15 Ex	DN 2	G 3/8	-	0 - 100 / 300 (NO)	1,3 l/min	-20 °C ... +40 °C	-20 °C ... +40 °C	250 / 160
KBS 15 Ex	DN 3	G 3/8	-	0 - 40 / 100 (NO)	5,2 l/min	-20 °C ... +40 °C	-20 °C ... +40 °C	250 / 160

length

co-ax type	ports	standard	1 limit switch inductive	2 limit switches inductive	1 limit switch mechanical	manual override
KBS 15 Ex (NC)	thread	182 mm	-	-	-	-
KBS 15 Ex (NO)	thread	195,5 mm	-	-	-	-

The valve's technical design is based on media and application requirements. This can lead to deviations from the general specifications shown on the data sheet with regards to the design, sealing materials and characteristics.

2/2-way valve
 direct actuated
 orifice
 pressure range
 ports

DN 2 - 50
 PN 0 - 100 bar
 threaded / flanged

function NC
 valve normally closed

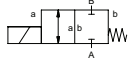

function NO
 valve normally open

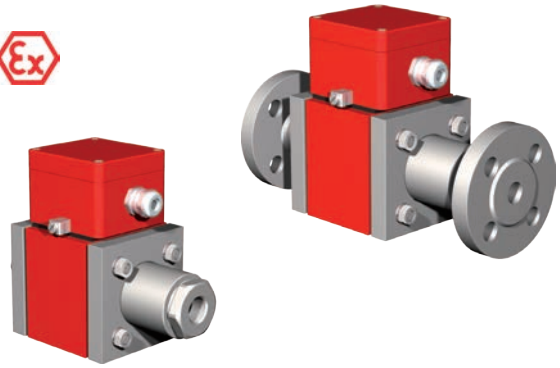
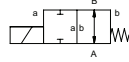

specifications

ex-protective classes	II 2 G Eex me II T4 and II 2 D IP 65 T 130°C PTB 02 ATEX 2120 x
design	pressure balanced, with spring return
function	NC - normally closed NO - normally open (only MK/FK)
body materials	brass, galvanized steel, nickel plated brass, nickel plated steel, without non-ferrous metals, stainless steel
seal materials	NBR, PTFE, FPM, CR, EPDM, special materials
media	gaseous, liquid, highly viscous, contaminated
actuation	DC direct-current magnet AC direct-current magnet, with integrated / separate rectifier
nominal voltage	DC 24 V / AC 230 V
electrical connection	M16x1,5 terminal box
insulation class	H - 180 °C
enclosure protection	IP 65
energized duty rating	ED 100 %
flow direction	A ⇒ B B ⇒ A (Δp 16 bar max.)
vacuum	leak rate < 10 ⁻⁶ mbar•l•s ⁻¹
options / accessories	special threads, special flanges, function NO, damping, limit switches (NAMUR), manual override, approvals, special voltage



certified

technical data

co-ax type	orifice [mm]	ports threaded	ports flanged	pressure range [bar]	Kv value A ⇒ B	media temperature	ambient temperature	switching time [ms] opening / closing
KB 15 Ex	DN 2	G 3/8	-	0 - 100	1,7 l/min	-20 °C ... +40 °C	-20 °C ... +40 °C	100 / 175
KB 15 Ex	DN 3	G 3/8	-	0 - 50	4,1 l/min	-20 °C ... +40 °C	-20 °C ... +40 °C	100 / 175
KB 15 Ex	DN 4	G 3/8	-	0 - 30	11,0 l/min	-20 °C ... +40 °C	-20 °C ... +40 °C	100 / 175
KB 15 Ex	DN 5	G 3/8	-	0 - 16	13,5 l/min	-20 °C ... +40 °C	-20 °C ... +40 °C	100 / 175
KB 15 Ex	DN 6	G 3/8	-	0 - 10	17,4 l/min	-20 °C ... +40 °C	-20 °C ... +40 °C	100 / 175
KB 15 Ex	DN 8	G 3/8	-	0 - 10	24,0 l/min	-20 °C ... +40 °C	-20 °C ... +40 °C	100 / 175
MK 10 Ex	DN 10	G 1/4 - G 3/4	-	0 - 16	2,5 m³/h	-20 °C ... +40 °C	-20 °C ... +40 °C	80 / 140
MK / FK 15 Ex	DN 15	G 3/8 - G 3/4	PN 16 / 40 / 100	0 - 16 / 40 / 64 / 100	4,8 m³/h	-20 °C ... +40 °C	-20 °C ... +40 °C	80 / 80
MK / FK 20 Ex	DN 20	G 3/4 - G 1 1/4	PN 16 / 40 / 100	0 - 16 / 40 / 64 / 100	7,4 m³/h	-20 °C ... +40 °C	-20 °C ... +40 °C	110 / 110
MK / FK 25 Ex	DN 25	G 1 - G 1 1/2	PN 16 / 40 / 100	0 - 16 / 40 / 64 / 100	11,2 m³/h	-20 °C ... +70 °C	-20 °C ... +70 °C	130 / 130
MK / FK 32 Ex	DN 32	G 1 1/4 - G 1 1/2	PN 16 / 40 / 100	0 - 16 / 40 / 64	14,1 m³/h	-20 °C ... +40 °C	-20 °C ... +40 °C	440 / 250
MK / FK 40 Ex	DN 40	G 1 1/2 - G 2	PN 16 / 40 / 100	0 - 16 / 40 / 64	18,4 m³/h	-20 °C ... +40 °C	-20 °C ... +40 °C	520 / 150
MK / FK 50 Ex	DN 50	G 2	PN 16	0 - 16	28,2 m³/h	-20 °C ... +40 °C	-20 °C ... +40 °C	400 / 400

length

co-ax type	ports	standard	1 limit switch inductive	2 limit switches inductive	1 limit switch mechanical	manual override
KB 15 Ex	thread	135 mm	-	-	-	-
MK 10 Ex	thread	159,5 mm	159,5 mm	159,5 mm	-	-
MK / FK 15 Ex	thread / flange	185 mm / 242 mm	234 mm / 291 mm	234 mm / 291 mm	-	224 mm / 281 mm
MK / FK 20 Ex	thread / flange	215 mm / 269 mm	259 mm / 313 mm	259 mm / 313 mm	-	259 mm / 313 mm
MK / FK 25 Ex	thread / flange	246 mm / 302 mm	299 mm / 355 mm	299 mm / 355 mm	-	299 mm / 355 mm
MK / FK 32 Ex	thread / flange	258 mm / 324 mm	299 mm / 365 mm	299 mm / 365 mm	-	299 mm / 365 mm
MK / FK 40 Ex	thread / flange	258 mm / 324 mm	299 mm / 365 mm	299 mm / 365 mm	-	299 mm / 365 mm
MK / FK 50 Ex	thread / flange	365 mm / 438 mm	365 mm / 438 mm	365 mm / 438 mm	-	365 mm / 438 mm

series MK / FK DR Ex certified valves

3/2-way valve

direct actuated

orifice

pressure range

ports

DN 10 - 50

PN 0 - 40 bar

threaded / flanged

function **NC**

valve normally closed

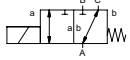

function **NO**

valve normally open

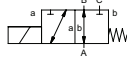

ATEX 

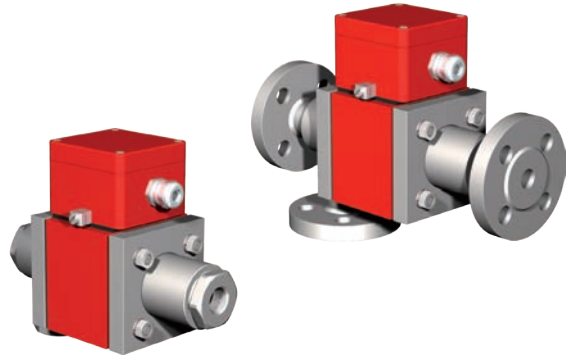

specifications

ex-protective classes	II 2 G Eex me II T4 and II 2 D IP 65 T 130°C PTB 02 ATEX 2120 x
design	pressure balanced, with spring return, switching overlap
function	DR NC - normally closed (A ⇒ B) DR NO - normally open (A ⇒ B)
body materials	brass, galvanized steel, nickel plated steel, without non-ferrous metals, stainless steel
seal materials	NBR, PTFE, FPM, CR, EPDM, special materials
media	gaseous, liquid, highly viscous, contaminated
actuation	DC direct-current magnet AC direct-current magnet, with integrated / separate rectifier
nominal voltage	DC 24 V / AC 230 V
electrical connection	M16x1,5 terminal box
insulation class	H - 180 °C
enclosure protection	IP 65
energized duty rating	ED 100 %
flow direction	A ⇒ B / A ⇒ C B ⇒ A (Δp 16 bar max.)
vacuum	leak rate < 10 ⁻⁶ mbar•l•s ⁻¹
options / accessories	special threads, special flanges, function NO, damping, limit switches (NAMUR), manual override, approvals, special voltage

technical data

co-ax type	orifice [mm]	ports threaded	ports flanged	pressure range [bar]	Kv value A ⇒ B	media temperature	ambient temperature	switching time [ms] opening / closing
MK 10 DR Ex	DN 10	G 1/4 - G 3/4	-	0 - 16	2,6 m³/h	-20 °C ... +40 °C	-20 °C ... +40 °C	80 / 140
MK / FK 15 DR Ex	DN 15	G 3/8 - G 3/4	PN 16 / 40	0 - 16 / 40	4,3 m³/h	-20 °C ... +40 °C	-20 °C ... +40 °C	80 / 80
MK / FK 20 DR Ex	DN 20	G 3/4 - G 1 1/4	PN 16 / 40	0 - 16 / 40	6,7 m³/h	-20 °C ... +40 °C	-20 °C ... +40 °C	110 / 110
MK / FK 25 DR Ex	DN 25	G 1 - G 1 1/2	PN 16 / 40	0 - 16 / 40	11,2 m³/h	-20 °C ... +70 °C	-20 °C ... +70 °C	130 / 130
MK / FK 32 DR Ex	DN 32	G 1 1/4 - G 1 1/2	PN 16 / 40	0 - 16 / 40	14,1 m³/h	-20 °C ... +40 °C	-20 °C ... +40 °C	440 / 250
MK / FK 40 DR Ex	DN 40	G 1 1/2 - G 2	PN 16	0 - 16	18,4 m³/h	-20 °C ... +40 °C	-20 °C ... +40 °C	520 / 150
MK / FK 50 DR Ex	DN 50	G 2	PN 16	0 - 16	28,2 m³/h	-20 °C ... +40 °C	-20 °C ... +40 °C	400 / 400

length

co-ax type	ports	standard	1 limit switch inductive	2 limit switches inductive	1 limit switch mechanical	manual override
MK 10 DR Ex	thread	166,5 mm	-	-	-	-
MK / FK 15 DR Ex	thread / flange	210 mm / 266 mm	259 mm / 315 mm	259 mm / 315 mm	-	-
MK / FK 20 DR Ex	thread / flange	247 mm / 301 mm	291 mm / 345 mm	291 mm / 345 mm	-	-
MK / FK 25 DR Ex	thread / flange	281 mm / 337 mm	334 mm / 390 mm	334 mm / 390 mm	-	-
MK / FK 32 DR Ex	thread / flange	332 mm / 394 mm	373 mm / 435 mm	373 mm / 435 mm	-	373 mm / 435 mm
MK / FK 40 DR Ex	thread / flange	332 mm / 394 mm	373 mm / 435 mm	373 mm / 435 mm	-	373 mm / 435 mm
MK / FK 50 DR Ex	thread / flange	453 mm / 553 mm	453 mm / 553 mm	453 mm / 553 mm	-	453 mm / 553 mm

The valve's technical design is based on media and application requirements. This can lead to deviations from the general specifications shown on the data sheet with regards to the design, sealing materials and characteristics.

2/2-way valve

direct actuated

orifice

DN 10 - 25

pressure range

PN 0 - 40 bar

ports

threaded / flanged

function **NC**

valve normally closed

function **NO**

valve normally open

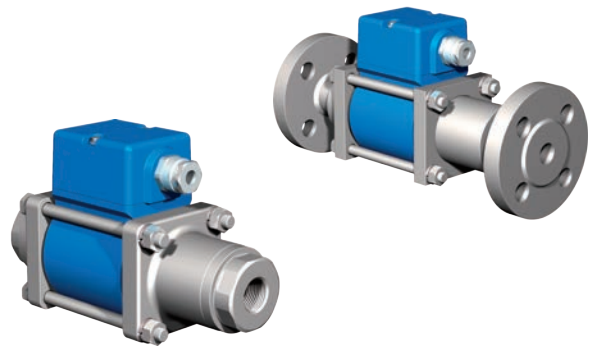
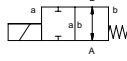
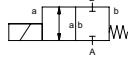

specifications

certificates	DIN EN ISO 23553-1 E DIN 32725
design	pressure balanced, with spring return
function	NC - normally closed NO - normally open
body materials	brass, galvanized steel
seal materials	FPM, PTFE
media	liquid fuels
actuation	DC direct-current magnet AC direct-current magnet, with integrated / separate rectifier
nominal voltage	DC 24 V / AC 230 V
electrical connection	plug acc. DIN EN 175301-803, form A, / M16x1,5 terminal box
insulation class	H - 180 °C
enclosure protection	IP 65
energized duty rating	ED 100 %
flow direction	A ⇒ B B ⇒ A (Δp 16 bar max.)
options / accessories	function NO, limit switches, mounting



certified

technical data

co-ax type	orifice [mm]	ports threaded	ports flanged	pressure range [bar]	Kv value A ⇒ B	media temperature	ambient temperature	switching time [ms] opening / closing
MK 10 TÜV	DN 10	G 1/4 - G 3/4	-	0 - 40	2,5 m³/h	-10 °C ... +140 °C	-10 °C ... +60 °C	25 / 25
MK / FK 15 TÜV	DN 15	G 3/8 - G 3/4	PN 40	0 - 40	4,8 m³/h	-10 °C ... +140 °C	-10 °C ... +60 °C	80 / 80
MK / FK 20 TÜV	DN 20	G 3/4 - G 1 1/4	PN 40	0 - 40	7,4 m³/h	-10 °C ... +140 °C	-10 °C ... +60 °C	110 / 110
FK 25 TÜV	DN 25	-	PN 40	0 - 40	11,2 m³/h	-10 °C ... +140 °C	-10 °C ... +60 °C	130 / 130

length

co-ax type	ports	standard	1 limit switch inductive	2 limit switches inductive	1 limit switch mechanical	manual override
MK 10 TÜV	thread	159,5 mm	-	-	-	-
MK / FK 15 TÜV	thread / flange	184 mm / 241 mm	-	-	204 mm / 261 mm	-
MK / FK 20 TÜV	thread / flange	215 mm / 269 mm	-	-	235 mm / 289 mm	-
FK 25 TÜV	flange	302 mm	-	-	355 mm	-

The valve's technical design is based on media and application requirements. This can lead to deviations from the general specifications shown on the data sheet with regards to the design, sealing materials and characteristics.

series MK / FK DR TÜV certified valves

3/2-way valve

direct actuated

orifice

pressure range

ports

DN 15 - 25

PN 0 - 40 bar

threaded / flanged

function NC

valve normally closed

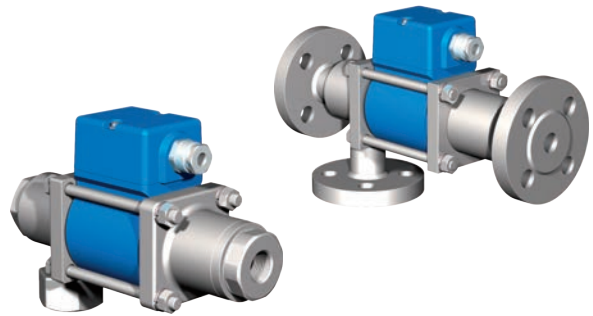
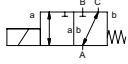

specifications

certificates	DIN EN ISO 23553-1 E DIN 32725
design	pressure balanced, with spring return, switching overlap
function	DR NC - normally closed (A ⇒ B)
body materials	galvanized steel
seal materials	FPM, PTFE
media	liquid fuels
actuation	DC direct-current magnet AC direct-current magnet, with separate rectifier
nominal voltage	DC 24 V / AC 230 V
electrical connection	M16x1,5 terminal box
insulation class	H - 180 °C
enclosure protection	IP 65
energized duty rating	ED 100 %
flow direction	A ⇒ B / A ⇒ C B ⇒ A (Δp 16 bar max.)
options / accessories	limit switches, mounting

technical data

co-ax type	orifice [mm]	ports threaded	ports flanged	pressure range [bar]	Kv value A ⇒ B	media temperature	ambient temperature	switching time [ms] opening / closing
MK / FK 15 DR TÜV	DN 15	G 3/8 - G 3/4	PN 40	0 - 40	4,3 m³/h	-10 °C ... +140 °C	-10 °C ... +60 °C	80 / 80
MK / FK 20 DR TÜV	DN 20	G 3/4 - G 1 1/4	PN 40	0 - 40	6,7 m³/h	-10 °C ... +140 °C	-10 °C ... +60 °C	110 / 110
FK 25 DR TÜV	DN 25	-	PN 40	0 - 40	11,2 m³/h	-10 °C ... +140 °C	-10 °C ... +60 °C	130 / 130

length

co-ax type	ports	standard	1 limit switch inductive	2 limit switches inductive	1 limit switch mechanical	manual override
MK / FK 15 DR TÜV	thread / flange	209 mm / 265 mm	-	-	229 mm / 285 mm	-
MK / FK 20 DR TÜV	thread / flange	247 mm / 301 mm	-	-	267 mm / 321 mm	-
FK 25 DR TÜV	flange	337 mm	-	-	390 mm	-

The valve's technical design is based on media and application requirements. This can lead to deviations from the general specifications shown on the data sheet with regards to the design, sealing materials and characteristics.

2/2-way valve

externally controlled

orifice

DN 10 - 15

pressure range

PN 0 - 100 bar

ports

threaded

function NC

valve normally closed

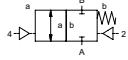

function NO

valve normally open

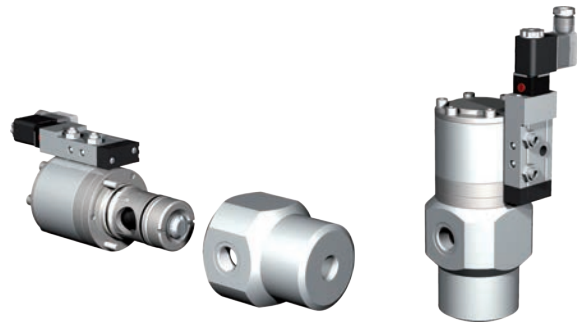
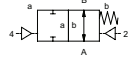

specifications

design	externally controlled, with spring return
function	NC - normally closed NO - normally open
body materials	aluminium, brass, stainless steel
seal materials	PU, NBR, PTFE, PE, FPM, EPDM, special materials
media	gaseous, liquid, highly viscous, contaminated
actuation	pneumatic actuation via 5/2-way pilot valve, hydraulic actuation via 4/2-way control valve
actuator ports	G 1/8 (pneumatic actuation), G 1/4 (hydraulic actuation, via adapter)
nominal voltage	DC 24 V / AC 230 V
electrical connection pilot valve	plug acc. DIN EN 175301-803 form B, LED
enclosure protection	IP 65
energized duty rating	ED 100 %
flow direction	A ⇌ B B ⇌ A
vacuum	leak rate < 10 ⁻⁶ mbar•l•s ⁻¹
options / accessories	valve body, function NO, leak ports, limit switches, manual override, approvals, mounting, special voltage, connector M12x1, explosion proof ATEX zone 1 and 2 cat. 3, pilot valve



cartridge

technical data

co-ax type	orifice [mm]	ports threaded	ports flanged	pressure range [bar]	Kv value A ⇌ B	media temperature	ambient temperature	switching time [ms] opening / closing
PCD-1 10	DN 10	G 3/8	-	0 - 50	3,0 m³/h	-20 °C ... +150 °C	-20 °C ... +150 °C	30-3000 / 30-3000
PCD-2 10	DN 10	G 3/8	-	0 - 100	3,0 m³/h	-20 °C ... +150 °C	-20 °C ... +150 °C	30-3000 / 30-3000
PCD-1 15	DN 15	G 1/2 - G 3/4	-	0 - 50	6,0 m³/h	-20 °C ... +150 °C	-20 °C ... +150 °C	100-3000 / 100-3000
PCD-2 15	DN 15	G 1/2 - G 3/4	-	0 - 100	6,0 m³/h	-20 °C ... +150 °C	-20 °C ... +150 °C	100-3000 / 100-3000

length

co-ax type	ports	standard	1 limit switch inductive	2 limit switches inductive	1 limit switch mechanical	manual override
PCD-1 10	thread	60 mm	60 mm	60 mm	-	via pilot valve
PCD-2 10	thread	60 mm	60 mm	60 mm	-	via pilot valve
PCD-1 15	thread	80 mm	80 mm	80 mm	-	via pilot valve
PCD-2 15	thread	80 mm	80 mm	80 mm	-	via pilot valve

The valve's technical design is based on media and application requirements. This can lead to deviations from the general specifications shown on the data sheet with regards to the design, sealing materials and characteristics.

series PCS cartridge valves

2/2-way valve

externally controlled

orifice

DN 10 - 15

pressure range

PN 0 - 150 bar

ports

threaded

function NC

valve normally closed

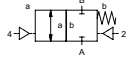

function NO

valve normally open

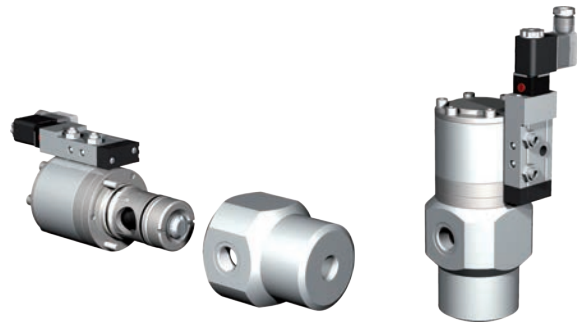
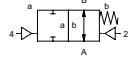

specifications

design	externally controlled, with spring return
function	NC - normally closed NO - normally open
body materials	aluminium, brass, stainless steel
seal materials	HNBR, FPM, EPDM, special materials
media	gaseous, liquid, highly viscous, contaminated
actuation	pneumatic actuation via 5/2-way pilot valve, hydraulic actuation via 4/2-way control valve
actuator ports	G 1/8 (pneumatic actuation), G 1/4 (hydraulic actuation, via adapter)
nominal voltage	DC 24 V / AC 230 V
electrical connection pilot valve	plug acc. DIN EN 175301-803 form B, LED
enclosure protection	IP 65
energized duty rating	ED 100 %
flow direction	A ⇌ B B ⇌ A
vacuum	leak rate < 10 ⁻⁶ mbar•l•s ⁻¹
options / accessories	valve body, function NO, leak ports, limit switches, manual override, approvals, mounting, special voltage, connector M12x1, explosion proof ATEX zone 1 and 2 cat. 3, pilot valve

technical data

co-ax type	orifice [mm]	ports threaded	ports flanged	pressure range [bar]	Kv value A ⇌ B	media temperature	ambient temperature	switching time [ms] opening / closing
PCS-1 10	DN 10	G 3/8	-	0 - 50	3,0 m ³ /h	-20 °C ... +150 °C	-20 °C ... +150 °C	30-3000 / 30-3000
PCS-2 10	DN 10	G 3/8	-	0 - 100	3,0 m ³ /h	-20 °C ... +150 °C	-20 °C ... +150 °C	30-3000 / 30-3000
PCS-1 15	DN 15	G 1/2 - G 3/4	-	0 - 50	6,0 m ³ /h	-20 °C ... +150 °C	-20 °C ... +150 °C	100-3000 / 100-3000
PCS-2 15	DN 15	G 1/2 - G 3/4	-	0 - 100	6,0 m ³ /h	-20 °C ... +150 °C	-20 °C ... +150 °C	100-3000 / 100-3000
PCS-3 15	DN 15	G 1/2 - G 3/4	-	0 - 150	6,0 m ³ /h	-20 °C ... +150 °C	-20 °C ... +150 °C	100-3000 / 100-3000

length

co-ax type	ports	standard	1 limit switch inductive	2 limit switches inductive	1 limit switch mechanical	manual override
PCS-1 10	thread	60 mm	60 mm	60 mm	-	via pilot valve
PCS-2 10	thread	60 mm	60 mm	60 mm	-	via pilot valve
PCS-1 15	thread	80 mm	80 mm	80 mm	-	via pilot valve
PCS-2 15	thread	80 mm	80 mm	80 mm	-	via pilot valve
PCS-3 15	thread	80 mm	80 mm	80 mm	-	via pilot valve

The valve's technical design is based on media and application requirements. This can lead to deviations from the general specifications shown on the data sheet with regards to the design, sealing materials and characteristics.

2/2-way valve

direct actuated

orifice

DN 15 - 50

pressure range

PN 0 - 10 bar

ports

threaded

function **NC**

valve normally closed

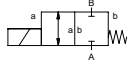

function **NO**

valve normally open

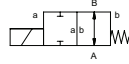

specifications

design	pressure balanced, with spring return
function	NC - normally closed NO - normally open
body materials	brass, nickel plated brass
seal materials	NBR, FPM
media	gaseous, liquid
actuation	DC direct-current magnet AC direct-current magnet, with integrated rectifier
nominal voltage	DC 24 V / AC 230 V
electrical connection	plug acc. DIN EN 175301-803, form A, LED
insulation class	H - 180 °C
enclosure protection	IP 65
energized duty rating	ED 100 %
flow direction	A ⇌ B
vacuum	low vacuum
options / accessories	function NO, manual override, mounting, special voltage, terminal box

technical data

co-ax type	orifice [mm]	ports threaded	ports flanged	pressure range [bar]	Kv value A ⇌ B	media temperature	ambient temperature	switching time [ms] opening / closing
RSV 12	DN 15	G 1/2 - G 3/4	-	0 - 10	3,2 m³/h	-10 °C ... +80 °C	-10 °C ... +80 °C	28 / 30
RSV 20	DN 20	G 3/4 - G 1	-	0 - 10	6,8 m³/h	-10 °C ... +80 °C	-10 °C ... +80 °C	120 / 160
RSV 25	DN 25	G 1 1/4	-	0 - 10	7,5 m³/h	-10 °C ... +80 °C	-10 °C ... +80 °C	130 / 200
RSV 32	DN 32	G 1 1/4 - G 1 1/2	-	0 - 10	8,2 m³/h	-10 °C ... +80 °C	-10 °C ... +80 °C	140 / 250
RSV 40	DN 40	G 1 1/2	-	0 - 10	14,0 m³/h	-10 °C ... +80 °C	-10 °C ... +80 °C	150 / 250
RSV 50	DN 50	G 2	-	0 - 10	19,0 m³/h	-10 °C ... +80 °C	-10 °C ... +80 °C	150 / 250

length

co-ax type	ports	standard	1 limit switch inductive	2 limit switches inductive	1 limit switch mechanical	manual override
RSV 12	thread	80 mm	-	-	-	80 mm
RSV 20	thread	97 mm	-	-	-	97 mm
RSV 25	thread	120 mm	-	-	-	-
RSV 32	thread	120 mm	-	-	-	-
RSV 40	thread	160 mm	-	-	-	-
RSV 50	thread	160 mm	-	-	-	-

The valve's technical design is based on media and application requirements. This can lead to deviations from the general specifications shown on the data sheet with regards to the design, sealing materials and characteristics.



lateral

series DRV lateral valves

3/2-way valve

direct actuated

orifice

DN 12 - 25

pressure range

PN 0 - 2 bar

ports

threaded

function NC

valve normally closed

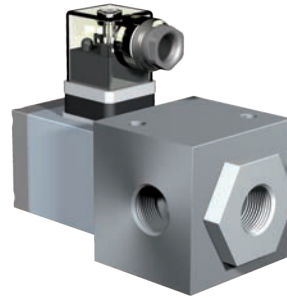
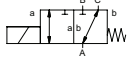

specifications

design	pressure balanced, with spring return, switching overlap
function	DR NC - normally closed (A ⇌ B)
body materials	aluminium
seal materials	NBR, CR
media	gaseous
actuation	DC direct-current magnet AC direct-current magnet, with integrated rectifier
nominal voltage	DC 24 V / AC 230 V
electrical connection	plug acc. DIN EN 175301-803, form A, LED
insulation class	H - 180 °C
enclosure protection	IP 65
energized duty rating	ED 100 %
flow direction	A ⇌ B / A ⇌ C B ⇌ A / C ⇌ A
vacuum	leak rate < 10 ⁻⁶ mbar•s ⁻¹
options / accessories	special voltage

technical data

co-ax type	orifice [mm]	ports threaded	ports flanged	pressure range [bar]	Kv value A ⇌ B	media temperature	ambient temperature	switching time [ms] opening / closing
DRV 12	DN 12	G 1/2	-	0 - 1	2,7 m³/h	-10 °C ... +80 °C	-10 °C ... +80 °C	40 / 25
DRV 20	DN 20	G 3/4	-	0 - 2	9,1 m³/h	-10 °C ... +80 °C	-10 °C ... +80 °C	160 / 100
DRV 25	DN 25	G 1	-	0 - 2	12,8 m³/h	-10 °C ... +80 °C	-10 °C ... +80 °C	160 / 100

length

co-ax type	ports	standard	1 limit switch inductive	2 limit switches inductive	1 limit switch mechanical	manual override
DRV 12	thread	60 mm	-	-	-	-
DRV 20	thread	100 mm	-	-	-	-
DRV 25	thread	100 mm	-	-	-	-

2/2-way valve
 direct actuated
 orifice
 pressure range
 ports

DN 2 - 6
 PN 0 - 130 bar
 threaded

function **NC**
 valve normally closed

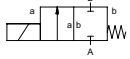

function **NO**
 valve normally open

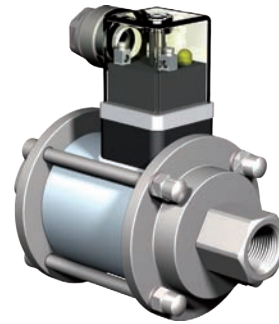
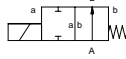

specifications

design	direct acting, with spring return
function	NC - normally closed NO - normally open
body materials	stainless steel
seal materials	NBR, PTFE, FPM, EPDM
media	gaseous, liquid
actuation	DC direct-current magnet AC direct-current magnet, with integrated / separate rectifier
nominal voltage	DC 24 V / AC 230 V
electrical connection	plug acc. DIN EN 175301-803, form A, LED
insulation class	H - 180 °C
enclosure protection	IP 65
energized duty rating	ED 100 %
flow direction	A ⇒ B
vacuum	leak rate < 10 ⁻⁶ mbar•l•s ⁻¹
options / accessories	function NO, approvals, mounting, special voltage, connector M12x1

technical data

co-ax type	orifice [mm]	ports threaded	ports flanged	pressure range [bar]	Kv value A ⇒ B	media temperature	ambient temperature	switching time [ms] opening / closing
A 45	DN 2	G 3/8	-	0 - 130	1,3 l/min	-10 °C ... +80 °C	-10 °C ... +80 °C	20 / 45
A 45	DN 4	G 3/8	-	0 - 40 / 60 (NO)	5,3 l/min	-10 °C ... +80 °C	-10 °C ... +80 °C	20 / 45
A 45	DN 6	G 3/8	-	0 - 10	9,8 l/min	-10 °C ... +80 °C	-10 °C ... +80 °C	20 / 45



high pressure

length

co-ax type	ports	standard	1 limit switch inductive	2 limit switches inductive	1 limit switch mechanical	manual override
A 45	thread	113 mm	-	-	-	-

The valve's technical design is based on media and application requirements. This can lead to deviations from the general specifications shown on the data sheet with regards to the design, sealing materials and characteristics.

series KB high pressure valves

2/2-way valve

direct actuated

orifice

DN 2 - 14

pressure range

PN 0 - 400 bar

ports

threaded

function NC

valve normally closed

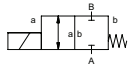

specifications

design	direct acting, with spring return
function	NC - normally closed
body materials	nickel plated steel, stainless steel
seal materials	NBR, PTFE, FPM, special materials
media	gaseous, liquid
actuation	DC direct-current magnet AC direct-current magnet, with integrated / separate rectifier
nominal voltage	DC 24 V / AC 230 V
electrical connection	plug acc. DIN EN 175301-803, form A, LED
insulation class	H - 180 °C
enclosure protection	IP 65
energized duty rating	ED 100 %
flow direction	A ⇒ B B ⇒ A (upon request)
vacuum	leak rate < 10 ⁻⁶ mbar•l•s ⁻¹
options / accessories	special threads, 2-coil operation, approvals, mounting, special voltage, connector M12x1, terminal box, ATEX zone 2 cat. 3 max 80°C, special version to -196 °C available

technical data

co-ax type	orifice [mm]	ports threaded	pressure range [bar] 1-coil operation	pressure range [bar] 2-coil operation	Kv value A ⇒ B	media temperature	ambient temperature	switching time [ms] opening / closing
KB 15	DN 2	G 3/8	0 - 300	0 - 400	1,7 l/min	-20 °C ... +100 °C	-20 °C ... +80 °C	60 / 170
KB 15	DN 3	G 3/8	0 - 250	0 - 300	4,1 l/min	-20 °C ... +100 °C	-20 °C ... +80 °C	60 / 170
KB 15	DN 4	G 3/8	0 - 120	0 - 150	11,0 l/min	-20 °C ... +100 °C	-20 °C ... +80 °C	60 / 170
KB 15	DN 5	G 3/8	0 - 80	0 - 100	13,5 l/min	-20 °C ... +100 °C	-20 °C ... +80 °C	60 / 170
KB 15	DN 6	G 3/8	0 - 50	0 - 70	17,4 l/min	-20 °C ... +100 °C	-20 °C ... +80 °C	60 / 170
KB 15	DN 8	G 3/8	0 - 30	0 - 40	24,0 l/min	-20 °C ... +100 °C	-20 °C ... +80 °C	60 / 170
KB 20	DN 8	G 1/2	0 - 50	-	1,8 m³/h	-20 °C ... +100 °C	-20 °C ... +80 °C	120 / 270
KB 20	DN 10	G 1/2	0 - 35	-	2,5 m³/h	-20 °C ... +100 °C	-20 °C ... +80 °C	120 / 270
KB 20	DN 12	G 1/2	0 - 25	-	2,9 m³/h	-20 °C ... +100 °C	-20 °C ... +80 °C	120 / 270
KB 20	DN 14	G 1/2	0 - 15	-	3,2 m³/h	-20 °C ... +100 °C	-20 °C ... +80 °C	120 / 270

length

co-ax type	ports	standard	1 limit switch inductive	2 limit switches inductive	1 limit switch mechanical	manual override
KB 15	thread	135 mm	-	-	-	-
KB 20	thread	160 mm	-	-	-	-

2/2-way valve
 direct actuated
 orifice DN 10
 pressure range PN 0 - 200 bar
 ports threaded



function **NC**
 valve normally closed

function **NO**
 valve normally open

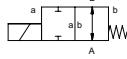
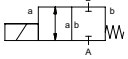

specifications

design	pressure balanced, with spring return
function	NC - normally closed NO - normally open
body materials	brass, stainless steel
seal materials	NBR, PTFE, FPM, CR, EPDM
media	gaseous, liquid
actuation	DC direct-current magnet AC direct-current magnet, with integrated / separate rectifier
nominal voltage	DC 24 V / AC 230 V
electrical connection	plug acc. DIN EN 175301-803, form A, LED
insulation class	H - 180 °C
enclosure protection	IP 65
energized duty rating	ED 100 %
flow direction	A ⇌ B B ⇌ A (upon request)
vacuum	leak rate < 10 ⁻⁶ mbar•l•s ⁻¹
options / accessories	function NO, limit switches, special voltage, connector M12x1, terminal box, ATEX zone 2 cat. 3 max 80°C

technical data

co-ax type	orifice [mm]	ports threaded	ports flanged	pressure range [bar]	Kv value A ⇌ B	media temperature	ambient temperature	switching time [ms] opening / closing
ECD-H 10	DN 10	G 3/8	-	0 - 200 / 150 (NO)	1,5 m³/h	-20 °C ... +160 °C	-20 °C ... +60 °C	250 / 110



high pressure

length

co-ax type	ports	standard	1 limit switch inductive	2 limit switches inductive	1 limit switch mechanical	manual override
ECD-H 10	thread	70 mm	-	-	-	-

The valve's technical design is based on media and application requirements. This can lead to deviations from the general specifications shown on the data sheet with regards to the design, sealing materials and characteristics.

type ECD-H DR high pressure valves

3/2-way valve
 direct actuated
 orifice DN 10
 pressure range PN 0 - 150 bar
 ports threaded

function **NC**
 valve normally closed

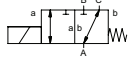

function **NO**
 valve normally open

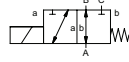

specifications

design	pressure balanced, with spring return, switching overlap
function	DR NC - normally closed (A ⇌ B) DR NO - normally open (A ⇌ B)
body materials	brass, stainless steel
seal materials	NBR, PTFE, FPM, CR, EPDM
media	gaseous, liquid
actuation	DC direct-current magnet AC direct-current magnet, with integrated / separate rectifier
nominal voltage	DC 24 V / AC 230 V
electrical connection	plug acc. DIN EN 175301-803, form A, LED
insulation class	H - 180 °C
enclosure protection	IP 65
energized duty rating	ED 100 %
flow direction	A ⇌ B / A ⇌ C B ⇌ A / C ⇌ A (upon request)
vacuum	leak rate < 10 ⁻⁶ mbar•l•s ⁻¹
options / accessories	function NO, limit switches, special voltage, connector M12x1, terminal box, ATEX zone 2 cat. 3 max 80°C

technical data

co-ax type	orifice [mm]	ports threaded	ports flanged	pressure range [bar]	Kv value A ⇌ B	media temperature	ambient temperature	switching time [ms] opening / closing
ECD-H 10 DR	DN 10	G 3/8	-	0 - 150	1,5 m³/h	-20 °C ... +160 °C	-20 °C ... +60 °C	250 / 110

length

co-ax type	ports	standard	1 limit switch inductive	2 limit switches inductive	1 limit switch mechanical	manual override
ECD-H 10 DR	thread	70 mm	-	-	-	-

The valve's technical design is based on media and application requirements. This can lead to deviations from the general specifications shown on the data sheet with regards to the design, sealing materials and characteristics.

2/2-way valve

direct actuated

orifice

DN 1,5 - 3

pressure range

PN 0 - 500 bar

ports

threaded

function **NC**

valve normally closed

function **NO**

valve normally open

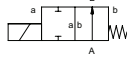
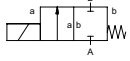

specifications

design	direct acting, with spring return
function	NC - normally closed
	NO - normally open
body materials	brass, nickel plated brass, stainless steel
seal materials	NBR, FPM
media	gaseous, liquid
actuation	DC direct-current magnet
	AC direct-current magnet, with integrated rectifier
nominal voltage	DC 24 V / AC 230 V
electrical connection	plug acc. DIN EN 175301-803, form A, LED
insulation class	H - 180 °C
enclosure protection	IP 65
energized duty rating	ED 100 %
flow direction	A ⇌ B
vacuum	leak rate < 10 ⁻⁶ mbar•s ⁻¹
options / accessories	special threads, function NO, approvals, mounting, special voltage, connector M12x1, terminal box

technical data

co-ax type	orifice [mm]	ports threaded	ports flanged	pressure range [bar]	Kv value A ⇌ B	media temperature	ambient temperature	switching time [ms] opening / closing
KBS 15	DN 1,5	G 3/8	-	0 - 500 / 500 (NO)	1,1 l/min	-20 °C ... +100 °C	-20 °C ... +80 °C	60 / 160
KBS 15	DN 2	G 3/8	-	0 - 400 / 300 (NO)	1,3 l/min	-20 °C ... +100 °C	-20 °C ... +80 °C	60 / 160
KBS 15	DN 3	G 3/8	-	0 - 250 / 100 (NO)	5,2 l/min	-20 °C ... +100 °C	-20 °C ... +80 °C	60 / 160

length

co-ax type	ports	standard	1 limit switch inductive	2 limit switches inductive	1 limit switch mechanical	manual override
KBS 15	thread	60 mm	-	-	-	-

The valve's technical design is based on media and application requirements. This can lead to deviations from the general specifications shown on the data sheet with regards to the design, sealing materials and characteristics.



high pressure

type MCF-H high pressure valves

2/2-way valve

externally controlled

orifice

DN 8

pressure range

PN 0 - 160 bar

ports

threaded

function NC

valve normally closed

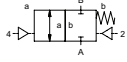

function NO

valve normally open

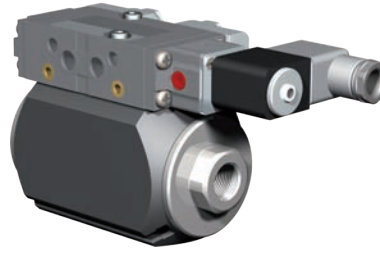
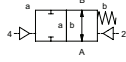

specifications

design	pressure balanced, with spring return
function	NC - normally closed NO - normally open
body materials	brass
seal materials	NBR, PTFE, FPM
media	emulsions, oils, neutral gases
actuation	pneumatic actuation via 5/2-way pilot valve
pilot valve interface	NAMUR / ISO 1
nominal voltage	DC 24 V / AC 230 V
electrical connection pilot valve	plug acc. DIN EN 175301-803 form B, LED
enclosure protection	IP 65
energized duty rating	ED 100 %
flow direction	A ⇒ B B ⇒ A (without actuation pressure Δp 16 bar max.)
vacuum	leak rate < 10^{-6} mbar•l•s ⁻¹
options / accessories	function NO, limit switches, manual override, mounting, special voltage, connector M12x1, explosion proof ATEX zone 1 and 2 cat. 3, pilot valve

technical data

co-ax type	orifice [mm]	ports threaded	ports flanged	pressure range [bar]	Kv value A ⇒ B	media temperature	ambient temperature	switching time [ms] opening / closing
MCF-H 08	DN 8	G 3/8	-	0 - 160	1,2 m³/h	-20 °C ... +160 °C	-20 °C ... +160 °C	30-3000 / 30-3000

length

co-ax type	ports	standard	1 limit switch	2 limit switches	1 limit switch mechanical	manual override
MCF-H 08	thread	120 mm	120 mm	120 mm	-	via pilot valve

2/2-way valve

externally controlled

orifice

DN 15 - 50

pressure range

PN 0 - 200 bar

ports

threaded / flanged

function NC

valve normally closed

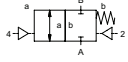

function NO

valve normally open

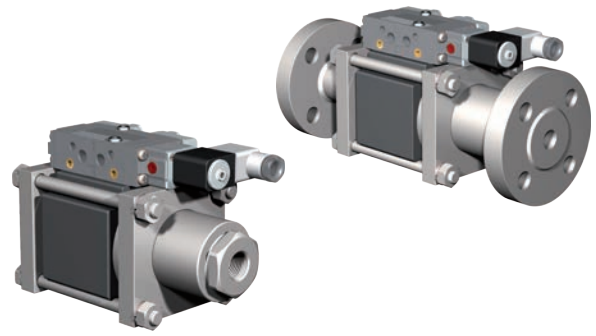
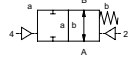

specifications

design	pressure balanced, with spring return
function	NC - normally closed
	NO - normally open
body materials	galvanized steel, nickel plated steel, without non-ferrous metals, stainless steel
seal materials	NBR, PTFE, FPM, CR, EPDM, special materials
media	gaseous, liquid, highly viscous, contaminated
actuation	pneumatic actuation via 5/2-way pilot valve, hydraulic actuation via 4/2-way control valve
pilot valve interface	NAMUR / ISO 1
nominal voltage	DC 24 V / AC 230 V
electrical connection pilot valve	plug acc. DIN EN 175301-803 form B, LED
enclosure protection	IP 65
energized duty rating	ED 100 %
flow direction	A ⇒ B
	B ⇒ A (without actuation pressure Δp 16 bar max.)
vacuum	leak rate < 10 ⁻⁶ mbar•l•s ⁻¹
options / accessories	special threads, special flanges, function NO, flush ports, leak ports, limit switches, manual override, approvals, mounting, special voltage, connector M12x1, explosion proof ATEX zone 1 and 2 cat. 3, pilot valve

technical data

co-ax type	orifice [mm]	ports threaded	ports flanged	pressure range [bar]	Kv value A ⇒ B	media temperature	ambient temperature	switching time [ms] opening / closing
VMK-H / VFK-H 15	DN 15	G 1/2	PN 160 / 250	0 - 200	5,6 m³/h	-20 °C ... +160 °C	-20 °C ... +160 °C	50-3000 / 50-3000
VMK-H / VFK-H 20	DN 20	G 3/4	PN 160 / 250	0 - 200	7,7 m³/h	-20 °C ... +160 °C	-20 °C ... +160 °C	50-3000 / 50-3000
VMK-H / VFK-H 25	DN 25	G 1	PN 160 / 250	0 - 200	12,6 m³/h	-20 °C ... +160 °C	-20 °C ... +160 °C	50-3000 / 50-3000
VMK-H / VFK-H 40	DN 40	G 1 1/2	PN 160 / 250	0 - 200	31,0 m³/h	-20 °C ... +160 °C	-20 °C ... +160 °C	100-3000 / 100-3000
VMK-H / VFK-H 50	DN 50	G 2	PN 160 / 250	0 - 200	43,0 m³/h	-20 °C ... +160 °C	-20 °C ... +160 °C	100-3000 / 100-3000



high pressure

length

co-ax type	ports	standard	1 limit switch inductive	2 limit switches inductive	1 limit switch mechanical	manual override
VMK-H / VFK-H 15	thread / flange	195 mm / 265 mm	225 mm / 295 mm	225 mm / 295 mm	215 mm / 285 mm	via pilot valve
VMK-H / VFK-H 20	thread / flange	215 mm / 288 mm	245 mm / 318 mm	245 mm / 318 mm	-	via pilot valve
VMK-H / VFK-H 25	thread / flange	230 mm / 305 mm	260 mm / 335 mm	260 mm / 335 mm	-	via pilot valve
VMK-H / VFK-H 40	thread / flange	312 mm / 385 mm	312 mm / 385 mm	312 mm / 385 mm	-	via pilot valve
VMK-H / VFK-H 50	thread / flange	312 mm / 385 mm	312 mm / 385 mm	312 mm / 385 mm	-	via pilot valve

series VMK-H / VFK-H DR high pressure valves

3/2-way valve

externally controlled

orifice

DN 15 - 50

pressure range

PN 0 - 200 bar

ports

threaded / flanged

function **NC**

valve normally closed

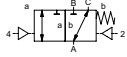

function **NO**

valve normally open

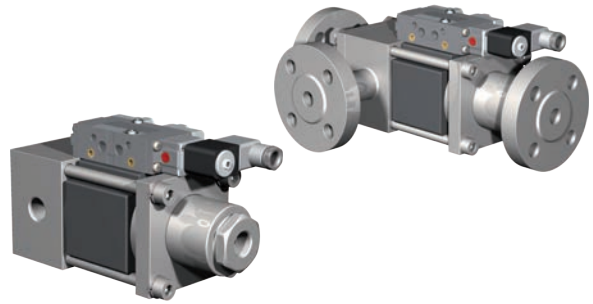
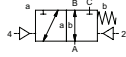

specifications

design	pressure balanced, with spring return, switching overlap
function	DR NC - normally closed (A ⇌ B) DR NO - normally open (A ⇌ B)
body materials	galvanized steel, nickel plated steel, without non-ferrous metals, stainless steel
seal materials	NBR, PTFE, FPM, CR, EPDM, special materials
media	gaseous, liquid, highly viscous, contaminated
actuation	pneumatic actuation via 5/2-way pilot valve, hydraulic actuation via 4/2-way control valve
pilot valve interface	NAMUR / ISO 1
nominal voltage	DC 24 V / AC 230 V
electrical connection pilot valve	plug acc. DIN EN 175301-803 form B, LED
enclosure protection	IP 65
energized duty rating	ED 100 %
flow direction	A ⇌ B / A ⇌ C B ⇌ A (without actuation pressure Δp 16 bar max.)
vacuum	leak rate < 10 ⁻⁶ mbar•l•s ⁻¹
options / accessories	special threads, special flanges, function NO, flush ports, leak ports, limit switches, manual override, approvals, mounting, special voltage, connector M12x1, explosion proof ATEX zone 1 and 2 cat. 3, pilot valve

technical data

co-ax type	orifice [mm]	ports threaded	ports flanged	pressure range [bar]	Kv value A ⇌ B	media temperature	ambient temperature	switching time [ms] opening / closing
VMK-H / VFK-H 15 DR	DN 15	G 1/2	PN 160 / 250	0 - 200	4,4 m³/h	-20 °C ... +160 °C	-20 °C ... +160 °C	50-3000 / 50-3000
VMK-H / VFK-H 20 DR	DN 20	G 3/4	PN 160 / 250	0 - 200	7,6 m³/h	-20 °C ... +160 °C	-20 °C ... +160 °C	50-3000 / 50-3000
VMK-H / VFK-H 25 DR	DN 25	G 1	PN 160 / 250	0 - 200	10,8 m³/h	-20 °C ... +160 °C	-20 °C ... +160 °C	50-3000 / 50-3000
VMK-H / VFK-H 40 DR	DN 40	G 1 1/2	PN 160 / 250	0 - 200	31,0 m³/h	-20 °C ... +160 °C	-20 °C ... +160 °C	100-3000 / 100-3000
VMK-H / VFK-H 50 DR	DN 50	G 2	PN 160 / 250	0 - 200	43,0 m³/h	-20 °C ... +160 °C	-20 °C ... +160 °C	100-3000 / 100-3000

length

co-ax type	ports	standard	1 limit switch inductive	2 limit switches inductive	1 limit switch mechanical	manual override
VMK-H / VFK-H 15 DR	thread / flange	225 mm / 313 mm	255 mm / 343 mm	255 mm / 343 mm	-	via pilot valve
VMK-H / VFK-H 20 DR	thread / flange	257 mm / 365 mm	287 mm / 395 mm	287 mm / 395 mm	-	via pilot valve
VMK-H / VFK-H 25 DR	thread / flange	265 mm / 370 mm	295 mm / 400 mm	295 mm / 400 mm	-	via pilot valve
VMK-H / VFK-H 40 DR	thread / flange	400 mm / 500 mm	400 mm / 500 mm	400 mm / 500 mm	-	via pilot valve
VMK-H / VFK-H 50 DR	thread / flange	400 mm / 500 mm	400 mm / 500 mm	400 mm / 500 mm	-	via pilot valve

2/2-way valve
externally controlled
orifice
pressure range
ports

DN 10 - 15
PN 0 - 500 bar
threaded

function **NC**
valve normally closed

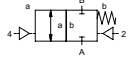

function **NO**
valve normally open

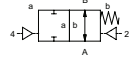

specifications

design	pressure balanced, with spring return
function	NC - normally closed NO - normally open
body materials	brass, stainless steel
seal materials	NBR, PTFE, FPM, CR, EPDM
media	gaseous, liquid
actuation	pneumatic actuation via 5/2-way pilot valve
actuator ports	G 1/8
nominal voltage	DC 24 V / AC 230 V
electrical connection pilot valve	plug acc. DIN EN 175301-803 form B, LED
enclosure protection	IP 65
energized duty rating	ED 100 %
flow direction	A ⇌ B B ⇌ A (upon request)
vacuum	leak rate < 10 ⁻⁴ mbar•l•s ⁻¹
options / accessories	function NO, limit switches, special voltage, connector M12x1, explosion proof ATEX zone 1 and 2 cat. 3, pilot valve

technical data

co-ax type	orifice [mm]	ports threaded	ports flanged	pressure range [bar]	Kv value A ⇌ B	media temperature	ambient temperature	switching time [ms] opening / closing
PCD 10	DN 10	G 3/8	-	0 - 250	1,5 m³/h	-10 °C ... +150 °C	-10 °C ... +150 °C	30-3000 / 30-3000
PCD-H 10	DN 10	G 3/8	-	0 - 500	1,5 m³/h	-10 °C ... +150 °C	-10 °C ... +150 °C	30-3000 / 30-3000
PCD-H 15	DN 15	G 1/2 - G 3/4	-	0 - 500	3,5 m³/h	-10 °C ... +150 °C	-10 °C ... +150 °C	30-3000 / 30-3000



high pressure

length

co-ax type	ports	standard	1 limit switch inductive	2 limit switches inductive	1 limit switch mechanical	manual override
PCD 10	thread	70 mm	-	-	-	via pilot valve
PCD-H 10	thread	80 mm	-	-	-	via pilot valve
PCD-H 15	thread	100 mm	-	-	-	via pilot valve

The valve's technical design is based on media and application requirements. This can lead to deviations from the general specifications shown on the data sheet with regards to the design, sealing materials and characteristics.

series PCD / PCD-H DR high pressure valves

3/2-way valve

externally controlled

orifice

DN 10 - 15

pressure range

PN 0 - 500 bar

ports

threaded

function **NC**

valve normally closed

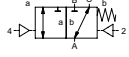

function **NO**

valve normally open

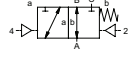

specifications

design	pressure balanced, with spring return, switching overlap
function	DR NC - normally closed (A ⇒ B) DR NO - normally open (A ⇒ B)
body materials	brass, stainless steel
seal materials	NBR, PTFE, FPM, CR, EPDM
media	gaseous, liquid
actuation	pneumatic actuation via 5/2-way pilot valve
actuator ports	G 1/8
nominal voltage	DC 24 V / AC 230 V
electrical connection pilot valve	plug acc. DIN EN 175301-803 form B, LED
enclosure protection	IP 65
energized duty rating	ED 100 %
flow direction	A ⇒ B / A ⇒ C B ⇒ A / C ⇒ A (upon request)
vacuum	leak rate < 10 ⁻⁴ mbar•l•s ⁻¹
options / accessories	function NO, limit switches, special voltage, connector M12x1, explosion proof ATEX zone 1 and 2 cat. 3, pilot valve

technical data

co-ax type	orifice [mm]	ports threaded	ports flanged	pressure range [bar]	Kv value A ⇒ B	media temperature	ambient temperature	switching time [ms] opening / closing
PCD 10 DR	DN 10	G 3/8	-	0 - 250	1,5 m³/h	-10 °C ... +150 °C	-10 °C ... +150 °C	30-3000 / 30-3000
PCD-H 10 DR	DN 10	G 3/8	-	0 - 500	1,5 m³/h	-10 °C ... +150 °C	-10 °C ... +150 °C	30-3000 / 30-3000
PCD-H 15 DR	DN 15	G 1/2 - G 3/4	-	0 - 500	3,5 m³/h	-10 °C ... +150 °C	-10 °C ... +150 °C	30-3000 / 30-3000

length

co-ax type	ports	standard	1 limit switch inductive	2 limit switches inductive	1 limit switch mechanical	manual override
PCD 10 DR	thread	70 mm	-	-	-	via pilot valve
PCD-H 10 DR	thread	80 mm	-	-	-	via pilot valve
PCD-H 15 DR	thread	100 mm	-	-	-	via pilot valve

2/2-way valve coaxial
externally controlled
orifice
pressure range
ports

DN 8
PN 0 - 40 bar
threaded

function **NC**
valve normally closed

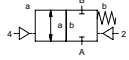

function **NO**
valve normally open

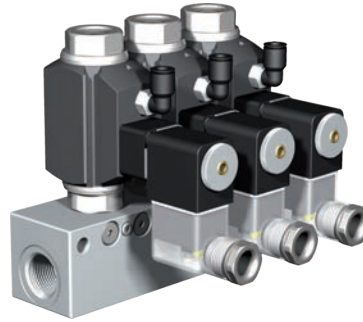
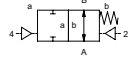

specifications

design	pressure balanced, with spring return
function	NC - normally closed NO - normally open
body materials valve	brass
body materials manifold	aluminium
seal materials	NBR, FPM, PE, PU, PTFE
media	emulsions, oils, neutral gases
actuation	pneumatic actuation via 3/2-way pilot valve (5/2-way pilot valve separately)
pilot valve interface	co-ax
nominal voltage	DC 24 V / AC 230 V
electrical connection pilot valve	plug acc. DIN EN 175301-803 form B, LED
enclosure protection	IP 65
energized duty rating	ED 100 %
flow direction	A ⇒ B B ⇒ A (without actuation pressure Δp 16 bar max.)
vacuum	leak rate < 10 ⁻⁶ mbar•l•s ⁻¹
options / accessories	function NO, limit switches, manual override, mounting, special voltage, connector M12x1, explosion proof ATEX zone 1 and 2 cat. 3, pilot valve

technical data

co-ax type	orifice [mm]	valve ports threaded	manifold ports threaded	pressure range [bar]	Kv value A ⇒ B	media temperature	ambient temperature	switching time [ms] opening / closing
CFM 08	DN 8	G 3/8	G 1/2	0 - 40	1,6 m³/h	-20 °C ... +120 °C	-20 °C ... +120 °C	70 / 80



manifolds & modules

length

co-ax type	manifold 1-station	manifold 2-station	manifold 3-station	manifold 4-station	manifold 5-station	manifold 6-station	manifold 7-station	manifold 8-station	manifold segment
CFM 08	-	100 mm	140 mm	180 mm	215 mm	-	-	-	-

The valve's technical design is based on media and application requirements. This can lead to deviations from the general specifications shown on the data sheet with regards to the design, sealing materials and characteristics.

type MCF manifolds

2/2-way valve coaxial
externally controlled

orifice DN 8
pressure range PN 0 - 100 bar
ports threaded

function **NC**
valve normally closed

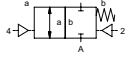

function **NO**
valve normally open

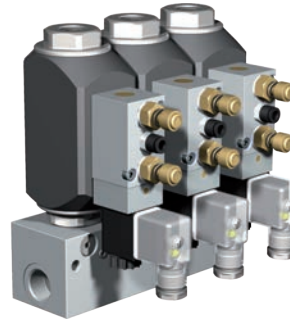
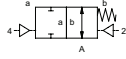

specifications

design	pressure balanced, with spring return
function	NC - normally closed NO - normally open
body materials valve	brass
body materials manifold	aluminium
seal materials	NBR, FPM, PTFE
media	emulsions, oils, neutral gases
actuation	pneumatic actuation via 5/2-way pilot valve
pilot valve interface	co-ax
nominal voltage	DC 24 V / AC 230 V
electrical connection pilot valve	plug acc. DIN EN 175301-803 form B, LED
enclosure protection	IP 65
energized duty rating	ED 100 %
flow direction	A ⇒ B B ⇒ A (without actuation pressure Δp 16 bar max.)
vacuum	leak rate < 10^{-6} mbar•l•s ⁻¹
options / accessories	function NO, limit switches, manual override, mounting, special voltage, connector M12x1, explosion proof ATEX zone 1 and 2 cat. 3, pilot valve

technical data

co-ax type	orifice [mm]	valve ports threaded	manifold ports threaded	pressure range [bar]	Kv value A ⇒ B	media temperature	ambient temperature	switching time [ms] opening / closing
MCF 08	DN 8	G 3/8	G 1/2	0 - 100	1,6 m³/h	-20 °C ... +160 °C	-20 °C ... +160 °C	30-3000 / 30-3000
MCF-H 08	DN 8	G 3/8	G 1/2	0 - 160	1,2 m³/h	-20 °C ... +160 °C	-20 °C ... +160 °C	30-3000 / 30-3000

length

co-ax type	manifold 1-station	manifold 2-station	manifold 3-station	manifold 4-station	manifold 5-station	manifold 6-station	manifold 7-station	manifold 8-station	manifold segment
MCF 08	-	110 mm	160 mm	215 mm	265 mm	-	-	-	-
MCF-H 08	-	110 mm	160 mm	215 mm	265 mm	-	-	-	-

The valve's technical design is based on media and application requirements. This can lead to deviations from the general specifications shown on the data sheet with regards to the design, sealing materials and characteristics.

2/2-way valve coaxial

direct actuated

orifice

DN 10 - 25

pressure range

PN 0 - 100 bar

ports

threaded

function **NC**

valve normally closed

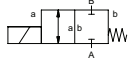

function **NO**

valve normally open

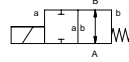

specifications

design	pressure balanced, with spring return
function	NC - normally closed
	NO - normally open
body materials valve	brass, galvanized steel, nickel plated brass, nickel plated steel, stainless steel
body materials module	aluminium, stainless steel
seal materials	NBR, PTFE, FPM, CR, EPDM, special materials
media	gaseous, liquid, highly viscous, contaminated
actuation	DC direct-current magnet
	AC direct-current magnet, with integrated rectifier
nominal voltage	DC 24 V / AC 230 V
electrical connection	plug acc. DIN EN 175301-803, form A, LED
insulation class	H - 180 °C
enclosure protection	IP 65
energized duty rating	ED 100 %
flow direction	A ⇒ B
	B ⇒ A (Δp 16 bar max.)
vacuum	leak rate < 10 ⁻⁶ mbar•l•s ⁻¹
options / accessories	special threads, function NO, damping, limit switches, manual override, mounting, special voltage, connector M12x1,
	terminal box, ATEX zone 2 cat. 3 max 80°C

technical data

co-ax type	orifice [mm]	valve ports threaded	manifold ports threaded	pressure range [bar]	Kv value A ⇒ B	media temperature	ambient temperature	switching time [ms] opening / closing
MK 10	DN 10	G 1/4 - G 3/4	G 1	0 - 16 / 40 / 64	2,5 m³/h	-20 °C ... +120 °C	-10 °C ... +80 °C	25 / 25
MK 15	DN 15	G 3/8 - G 3/4	G 1	0 - 16 / 40 / 64 / 100	4,8 m³/h	-20 °C ... +160 °C	-20 °C ... +80 °C	80 / 80
MK 20	DN 20	G 3/4 - G 1 1/4	G 1 1/4	0 - 16 / 40 / 64 / 100	7,4 m³/h	-20 °C ... +160 °C	-20 °C ... +80 °C	110 / 110
MK 25	DN 25	G 1 - G 1 1/2	G 1 1/2	0 - 16 / 40 / 64 / 100	11,2 m³/h	-20 °C ... +160 °C	-20 °C ... +80 °C	130 / 130



manifolds & modules

length

co-ax type	module 1-station	module 2-station	module 3-station	module 4-station	module 5-station	module 6-station	module 7-station	module 8-station	module segment
MK 10	75 mm	128 mm	181 mm	234 mm	287 mm	340 mm	393 mm	446 mm	53 mm
MK 15	110 mm	182 mm	254 mm	326 mm	398 mm	470 mm	542 mm	614 mm	72 mm
MK 20	125 mm	209 mm	293 mm	377 mm	461 mm	545 mm	629 mm	713 mm	84 mm
MK 25	145 mm	239 mm	333 mm	427 mm	521 mm	615 mm	709 mm	803 mm	94 mm

The valve's technical design is based on media and application requirements. This can lead to deviations from the general specifications shown on the data sheet with regards to the design, sealing materials and characteristics.

series VMK modules

2/2-way valve coaxial
externally controlled

orifice DN 10 - 32
pressure range PN 0 - 100 bar
ports threaded

function **NC**
valve normally closed

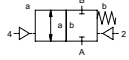

function **NO**
valve normally open

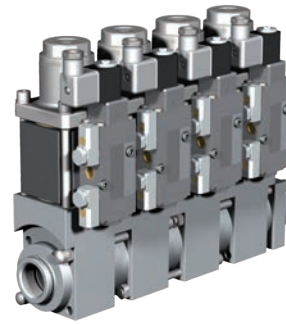
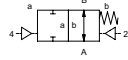

specifications

design	pressure balanced, with spring return
function	NC - normally closed NO - normally open
body materials valve	brass, galvanized steel, nickel plated brass, nickel plated steel, stainless steel
body materials module	aluminium, stainless steel
seal materials	NBR, PTFE, FPM, CR, EPDM, special materials
media	gaseous, liquid, highly viscous, contaminated
actuation	pneumatic actuation via 5/2-way pilot valve, hydraulic actuation via 4/2-way control valve
pilot valve interface	NAMUR / ISO 1
nominal voltage	DC 24 V / AC 230 V
electrical connection pilot valve	plug acc. DIN EN 175301-803 form B, LED
enclosure protection	IP 65
energized duty rating	ED 100 %
flow direction	A ⇒ B B ⇒ A (without actuation pressure Δp 16 bar max.)
vacuum	leak rate < 10 ⁻⁶ mbar•l•s ⁻¹
options / accessories	special threads, function NO, flush ports, leak ports, limit switches, manual override, mounting, special voltage, connector M12x1, explosion proof ATEX zone 1 and 2 cat. 3, pilot valve

technical data

co-ax type	orifice [mm]	valve ports threaded	manifold ports threaded	pressure range [bar]	Kv value A ⇒ B	media temperature	ambient temperature	switching time [ms] opening / closing
VMK 10	DN 10	G 1/4 - G 3/4	G 1	0 - 16 / 40 / 64 / 100	2,5 m³/h	-20 °C ... +160 °C	-20 °C ... +160 °C	30-3000 / 50-3000
VMK 15	DN 15	G 3/8 - G 3/4	G 1	0 - 16 / 40 / 64 / 100	5,7 m³/h	-20 °C ... +160 °C	-20 °C ... +160 °C	50-3000 / 50-3000
VMK 20	DN 20	G 3/4 - G 1 1/4	G 1 1/4	0 - 16 / 40 / 64 / 100	8,8 m³/h	-20 °C ... +160 °C	-20 °C ... +160 °C	50-3000 / 50-3000
VMK 25	DN 25	G 1 - G 1 1/2	G 1 1/2	0 - 16 / 40 / 64 / 100	13,3 m³/h	-20 °C ... +160 °C	-20 °C ... +160 °C	50-3000 / 50-3000
VMK 32	DN 32	G 1 1/4 - G 1 1/2	G 1 1/2	0 - 16 / 40 / 64 / 100	20,0 m³/h	-20 °C ... +160 °C	-20 °C ... +160 °C	100-3000 / 100-3000

length

co-ax type	module 1-station	module 2-station	module 3-station	module 4-station	module 5-station	module 6-station	module 7-station	module 8-station	module segment
VMK 10	75 mm	128 mm	181 mm	234 mm	287 mm	340 mm	393 mm	446 mm	53 mm
VMK 15	110 mm	182 mm	254 mm	326 mm	398 mm	470 mm	542 mm	614 mm	72 mm
VMK 20	125 mm	209 mm	293 mm	377 mm	461 mm	545 mm	629 mm	713 mm	84 mm
VMK 25	145 mm	239 mm	333 mm	427 mm	521 mm	615 mm	709 mm	803 mm	94 mm
VMK 32	145 mm	239 mm	333 mm	427 mm	521 mm	615 mm	709 mm	803 mm	94 mm

The valve's technical design is based on media and application requirements. This can lead to deviations from the general specifications shown on the data sheet with regards to the design, sealing materials and characteristics.

2/2-way valve cartridge

externally controlled

orifice

DN 10 - 15

pressure range

PN 0 - 100 bar

ports

threaded

function **NC**

valve normally closed

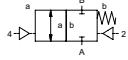

function **NO**

valve normally open

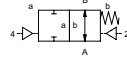

specifications

design	pressure balanced, with spring return
function	NC - normally closed
	NO - normally open
body materials valve	stainless steel
body materials module	aluminium
seal materials	PU, NBR, PTFE, PE, FPM, EPDM, special materials
media	gaseous, liquid, highly viscous, contaminated
actuation	pneumatic actuation via 5/2-way pilot valve, hydraulic actuation via 4/2-way control valve
actuator ports	G 1/8 (pneumatic actuation), G 1/4 (hydraulic actuation, via adapter)
nominal voltage	DC 24 V / AC 230 V
electrical connection pilot valve	plug acc. DIN EN 175301-803 form B, LED
enclosure protection	IP 65
energized duty rating	ED 100 %
flow direction	A ⇒ B
	B ⇒ A
vacuum	leak rate < 10 ⁻⁶ mbar•l•s ⁻¹
options / accessories	function NO, leak ports, limit switches, manual override, mounting, special voltage, connector M12x1, explosion proof ATEX zone 1 and 2 cat. 3, manual stroke adjustment, bypass with adjustable throttle, pilot valve

technical data

co-ax type	orifice [mm]	valve ports threaded	manifold ports threaded	pressure range [bar]	Kv value A ⇒ B	media temperature	ambient temperature	switching time [ms] opening / closing
PCD-1 10	DN 10	G 1/2	G 3/4	0 - 50	3,0 m³/h	-20 °C ... +150 °C	-20 °C ... +150 °C	30-3000 / 30-3000
PCD-2 10	DN 10	G 1/2	G 3/4	0 - 100	3,0 m³/h	-20 °C ... +150 °C	-20 °C ... +150 °C	30-3000 / 30-3000
PCD-1 15	DN 15	G 3/4	G 1	0 - 50	6,0 m³/h	-20 °C ... +150 °C	-20 °C ... +150 °C	100-3000 / 100-3000
PCD-2 15	DN 15	G 3/4	G 1	0 - 100	6,0 m³/h	-20 °C ... +150 °C	-20 °C ... +150 °C	100-3000 / 100-3000



manifolds & modules

length

co-ax type	module 1-station	module 2-station	module 3-station	module 4-station	module 5-station	module 6-station	module 7-station	module 8-station	module segment
PCD-1 10	106,5 mm	176,5 mm	246,5 mm	316,5 mm	386,5 mm	456,5 mm	526,5 mm	596,5 mm	70 mm
PCD-2 10	106,5 mm	176,5 mm	246,5 mm	316,5 mm	386,5 mm	456,5 mm	526,5 mm	596,5 mm	70 mm
PCD-1 15	130 mm	222mm	314 mm	406 mm	498 mm	590 mm	682 mm	774 mm	92 mm
PCD-2 15	130 mm	222mm	314 mm	406 mm	498 mm	590 mm	682 mm	774 mm	92 mm

The valve's technical design is based on media and application requirements. This can lead to deviations from the general specifications shown on the data sheet with regards to the design, sealing materials and characteristics.

series PCS modules

2/2-way valve cartridge

externally controlled

orifice

DN 10 - 15

pressure range

PN 0 - 100 bar

ports

threaded

function **NC**

valve normally closed

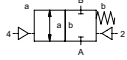

function **NO**

valve normally open

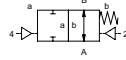

specifications

design	pressure balanced, with spring return
function	NC - normally closed
	NO - normally open
body materials valve	stainless steel
body materials module	aluminium
seal materials	HNBR, FPM, EPDM, special materials
media	gaseous, liquid, highly viscous, contaminated
actuation	pneumatic actuation via 5/2-way pilot valve, hydraulic actuation via 4/2-way control valve
actuator ports	G 1/8 (pneumatic actuation), G 1/4 (hydraulic actuation, via adapter)
nominal voltage	DC 24 V / AC 230 V
electrical connection pilot valve	plug acc. DIN EN 175301-803 form B, LED
enclosure protection	IP 65
energized duty rating	ED 100 %
flow direction	A ⇒ B
	B ⇒ A
vacuum	leak rate < 10 ⁻⁶ mbar•l•s ⁻¹
options / accessories	function NO, leak ports, limit switches, manual override, mounting, special voltage, connector M12x1, explosion proof ATEX zone 1 and 2 cat. 3, manual stroke adjustment, bypass with adjustable throttle, pilot valve

technical data

co-ax type	orifice [mm]	valve ports threaded	manifold ports threaded	pressure range [bar]	Kv value A ⇒ B	media temperature	ambient temperature	switching time [ms] opening / closing
PCS-1 10	DN 10	G 1/2	G 3/4	0 - 50	3,0 m³/h	-20 °C ... +150 °C	-20 °C ... +150 °C	30-3000 / 30-3000
PCS-2 10	DN 10	G 1/2	G 3/4	0 - 100	3,0 m³/h	-20 °C ... +150 °C	-20 °C ... +150 °C	30-3000 / 30-3000
PCS-1 15	DN 15	G 3/4	G 1	0 - 50	6,0 m³/h	-20 °C ... +150 °C	-20 °C ... +150 °C	100-3000 / 100-3000
PCS-2 15	DN 15	G 3/4	G 1	0 - 100	6,0 m³/h	-20 °C ... +150 °C	-20 °C ... +150 °C	100-3000 / 100-3000

length

co-ax type	module 1-station	module 2-station	module 3-station	module 4-station	module 5-station	module 6-station	module 7-station	module 8-station	module segment
PCS-1 10	106,5 mm	176,5 mm	246,5 mm	316,5 mm	386,5 mm	456,5 mm	526,5 mm	596,5 mm	70 mm
PCS-2 10	106,5 mm	176,5 mm	246,5 mm	316,5 mm	386,5 mm	456,5 mm	526,5 mm	596,5 mm	70 mm
PCS-1 15	130 mm	222mm	314 mm	406 mm	498 mm	590 mm	682 mm	774 mm	92 mm
PCS-2 15	130 mm	222mm	314 mm	406 mm	498 mm	590 mm	682 mm	774 mm	92 mm

The valve's technical design is based on media and application requirements. This can lead to deviations from the general specifications shown on the data sheet with regards to the design, sealing materials and characteristics.

pressure limitation valve

manual externally controlled

orifice DN 8 - 65

pressure range PN 0 - 200 bar

ports threaded / flanged

(3-) HPB 15 / 32 / 50

(3-) HPB 08 / 65

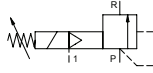
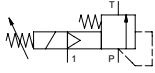

specifications

design	externally controlled, with / without spring return
function	manual stepless pressure regulation
body materials	brass, galvanized steel
seal materials	NBR, PTFE, FPM, special materials
media	liquid, highly viscous, contaminated
control	via 3/2-way pilot valve during low pressure circulation mode, manual stepless pressure regulation
actuator ports	G 1/8
nominal voltage	DC 24 V / AC 230 V
electrical connection pilot valve	plug acc. DIN EN 175301-803 form B, LED
enclosure protection	IP 65
energized duty rating	ED 100 %
flow direction	P ⇒ T / P ⇒ R
options / accessories	SAE - connection, security valve, mounting, special voltage, connector M12x1, two pressure regulator, pilot valve

technical data

co-ax type	orifice [mm]	ports threaded	ports flanged	pressure regulation range [bar]	Kv value	media temperature	ambient temperature	operating time [ms]
(3-) HPB 08	DN 8	G 3/8	-	10 - 200	1,1 m³/h	0 °C ... +60 °C	0 °C ... +50 °C	< 200
(3-) HPB-H 12 - 160	DN 12	G 1	DIN ISO 6162	10 - 160	5,0 m³/h	0 °C ... +60 °C	0 °C ... +50 °C	< 900
(3-) HPB-H 12 - 200	DN 12	G 1	DIN ISO 6162	10 - 200	5,0 m³/h	0 °C ... +60 °C	0 °C ... +50 °C	< 900
(3-) HPB-N 15	DN 15	G 1	DIN ISO 6162	1 - 16	6,0 m³/h	0 °C ... +60 °C	0 °C ... +50 °C	< 900
(3-) HPB-S 15	DN 15	G 1	DIN ISO 6162	5 - 64	6,0 m³/h	0 °C ... +60 °C	0 °C ... +50 °C	< 900
(3-) HPB-H 15	DN 15	G 1	DIN ISO 6162	5 - 120	6,0 m³/h	0 °C ... +60 °C	0 °C ... +50 °C	< 900
(3-) HPB-N 32	DN 32	G 1 1/2	DIN ISO 6162	1 - 16	24,0 m³/h	0 °C ... +60 °C	0 °C ... +50 °C	< 900
(3-) HPB-S 32	DN 32	G 1 1/2	DIN ISO 6162	5 - 64	24,0 m³/h	0 °C ... +60 °C	0 °C ... +50 °C	< 900
(3-) HPB-H 32	DN 32	G 1 1/2	DIN ISO 6162	5 - 120	14,4 m³/h	0 °C ... +60 °C	0 °C ... +50 °C	< 900
(3-) HPB-S 50	DN 50	G 1 1/2	DIN ISO 6162	5 - 64	48,0 m³/h	0 °C ... +60 °C	0 °C ... +50 °C	< 900
(3-) HPB 65	DN 65	-	PN 64	5 - 64	60,0 m³/h	0 °C ... +60 °C	0 °C ... +50 °C	< 900

length

co-ax type	ports	standard	1 limit switch inductive	2 limit switches inductive	1 limit switch mechanical	manual override
(3-) HPB 08	thread	Ø 74 mm	-	-	-	via pilot valve
(3-) HPB-H 12	thread / flange	97 mm / 97 mm	-	-	-	via pilot valve
(3-) HPB 15	thread / flange	97 mm / 97 mm	-	-	-	via pilot valve
(3-) HPB 32	thread / flange	160 mm / 160 mm	-	-	-	via pilot valve
(3-) HPB-S 50	thread / flange	160 mm / 160 mm	-	-	-	via pilot valve
(3-) HPB 65	flange	210 mm	-	-	-	via pilot valve



control

The valve's technical design is based on media and application requirements. This can lead to deviations from the general specifications shown on the data sheet with regards to the design, sealing materials and characteristics.

series SPB control valves

pressure limitation valve

proportional externally controlled

orifice DN 8 - 65

pressure range PN 0 - 200 bar

ports threaded / flanged

SPB 15 / 32 / 50

SPB 08 / 65

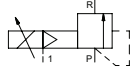
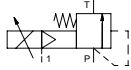

specifications

design	externally controlled, with / without spring return
function	stepless pressure regulation via control signal
body materials	brass, galvanized steel
seal materials	NBR, PTFE, FPM, special materials
media	liquid, highly viscous, contaminated
control	via 3/2-way proportional valve / 0 - 10 V
actuator ports	G 1/8
nominal voltage	DC 24 V
electrical connection pilot valve	plug with 7 contacts
enclosure protection	IP 65
energized duty rating	ED 100 %
flow direction	P ⇒ T / P ⇒ R
options / accessories	SAE - connection, mounting, actuation pressure gauge, transmitter of set point value

technical data

co-ax type	orifice [mm]	ports threaded	ports flanged	pressure regulation range [bar]	Kv value	media temperature	ambient temperature	operating time [ms]
SPB 08	DN 8	G 3/8	-	10 - 160 / 200	1,1 m³/h	0 °C ... +60 °C	0 °C ... +50 °C	< 200
SPB-H 12 - 160	DN 12	G 1	DIN ISO 6162	10 - 160	5,0 m³/h	0 °C ... +60 °C	0 °C ... +50 °C	< 900
SPB-H 12 - 200	DN 12	G 1	DIN ISO 6162	10 - 200	5,0 m³/h	0 °C ... +60 °C	0 °C ... +50 °C	< 900
SPB-N 15	DN 15	G 1	DIN ISO 6162	1 - 16	6,0 m³/h	0 °C ... +60 °C	0 °C ... +50 °C	< 900
SPB-S 15	DN 15	G 1	DIN ISO 6162	5 - 64	6,0 m³/h	0 °C ... +60 °C	0 °C ... +50 °C	< 900
SPB-H 15	DN 15	G 1	DIN ISO 6162	5 - 120	6,0 m³/h	0 °C ... +60 °C	0 °C ... +50 °C	< 900
SPB-N 32	DN 32	G 1 1/2	DIN ISO 6162	1 - 16	24,0 m³/h	0 °C ... +60 °C	0 °C ... +50 °C	< 900
SPB-S 32	DN 32	G 1 1/2	DIN ISO 6162	5 - 64	24,0 m³/h	0 °C ... +60 °C	0 °C ... +50 °C	< 900
SPB-H 32	DN 32	G 1 1/2	DIN ISO 6162	5 - 120	14,4 m³/h	0 °C ... +60 °C	0 °C ... +50 °C	< 900
SPB-S 50	DN 50	G 1 1/2	DIN ISO 6162	5 - 64	48,0 m³/h	0 °C ... +60 °C	0 °C ... +50 °C	< 900
SPB 65	DN 65	-	PN 64	5 - 64	60,0 m³/h	0 °C ... +60 °C	0 °C ... +50 °C	< 900

length

co-ax type	ports	standard	1 limit switch inductive	2 limit switches inductive	1 limit switch mechanical	manual override
SPB 08	thread	Ø 74 mm	-	-	-	-
SPB-H 12	thread / flange	97 mm / 97 mm	-	-	-	-
SPB 15	thread / flange	97 mm / 97 mm	-	-	-	-
SPB 32	thread / flange	160 mm / 160 mm	-	-	-	-
SPB-S 50	thread / flange	160 mm / 160 mm	-	-	-	-
SPB 65	flange	210 mm	-	-	-	-

The valve's technical design is based on media and application requirements. This can lead to deviations from the general specifications shown on the data sheet with regards to the design, sealing materials and characteristics.

pressure reduction valve
 manual externally controlled
 orifice DN 8 - 32
 pressure range PN 0 - 200 bar
 ports threaded



(3-) HPI / HPP PC



specifications

design	externally controlled, with spring return
function	manual stepless pressure regulation
body materials	aluminium, brass, stainless steel
seal materials	NBR, PTFE, FPM, EPDM, special materials
media	gaseous, liquid, highly viscous, contaminated
control	via 3/2-way pilot valve during low pressure circulation mode, manual stepless pressure regulation
actuator ports	G 1/8
nominal voltage	DC 24 V / AC 230 V
electrical connection pilot valve	plug acc. DIN EN 175301-803 form B, LED
enclosure protection	IP 65
energized duty rating	ED 100 %
flow direction	A ⇒ B
options / accessories	valve body, approvals, mounting, special voltage, connector M12x1, two pressure regulator, pilot valve

technical data

co-ax type	orifice [mm]	ports threaded	ports flanged	pressure regulation range [bar]	Kv value max.	media temperature	ambient temperature	operating time [ms]
(3-) HPI 08	DN 8	G 3/8	-	10 - 200	1,3 m³/h	0 °C ... +60 °C	0 °C ... +50 °C	< 100
(3-) HPP-1 15 PC	DN 15	G 1/2 - G 3/4	-	5 - 40	6,0 m³/h	0 °C ... +60 °C	0 °C ... +50 °C	< 200
(3-) HPP-2 15 PC	DN 15	G 1/2 - G 3/4	-	5 - 80	6,0 m³/h	0 °C ... +60 °C	0 °C ... +50 °C	< 200
(3-) HPP-3 15 PC	DN 15	G 1/2 - G 3/4	-	5 - 100	6,0 m³/h	0 °C ... +60 °C	0 °C ... +50 °C	< 200
(3-) HPI-1 32	DN 32	G 1 1/2	-	5 - 40	24,3 m³/h	0 °C ... +60 °C	0 °C ... +50 °C	< 200
(3-) HPI-2 32	DN 32	G 1 1/2	-	5 - 100	24,3 m³/h	0 °C ... +60 °C	0 °C ... +50 °C	< 200

length

co-ax type	ports	standard	1 limit switch inductive	2 limit switches inductive	1 limit switch mechanical	manual override
(3-) HPI 08	thread	Ø 74 mm	-	-	-	via pilot valve
(3-) HPP-1 15 PC	thread	80 mm	-	-	-	via pilot valve
(3-) HPP-2 15 PC	thread	80 mm	-	-	-	via pilot valve
(3-) HPP-3 15 PC	thread	80 mm	-	-	-	via pilot valve
(3-) HPI-1 32	thread	Ø 129 mm	-	-	-	via pilot valve
(3-) HPI-2 32	thread	Ø 129 mm	-	-	-	via pilot valve



control

The valve's technical design is based on media and application requirements. This can lead to deviations from the general specifications shown on the data sheet with regards to the design, sealing materials and characteristics.

series SPI / SPP PC control valves

pressure reduction valve

proportional externally controlled

orifice DN 8 - 32

pressure range PN 0 - 200 bar

ports threaded

SPI / SPP PC

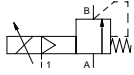

specifications

design	externally controlled, with spring return
function	stepless pressure regulation via control signal
body materials	aluminium, brass, stainless steel
seal materials	NBR, PTFE, FPM, EPDM, special materials
media	gaseous, liquid, highly viscous, contaminated
control	via 3/2-way proportional valve / 0 - 10 V
actuator ports	G 1/8
nominal voltage	DC 24 V
electrical connection pilot valve	plug with 7 contacts
enclosure protection	IP 65
energized duty rating	ED 100 %
flow direction	A ⇒ B
options / accessories	valve body, approvals, mounting, transmitter of set point value

technical data

co-ax type	orifice [mm]	ports threaded	ports flanged	pressure regulation range [bar]	Kv value max.	media temperature	ambient temperature	operating time [ms]
SPI 08	DN 8	G 3/8	-	10 - 200	1,3 m³/h	0 °C ... +60 °C	0 °C ... +50 °C	< 100
SPP-1 15 PC	DN 15	G 1/2 - G 3/4	-	5 - 40	6,0 m³/h	0 °C ... +60 °C	0 °C ... +50 °C	< 200
SPP-2 15 PC	DN 15	G 1/2 - G 3/4	-	5 - 80	6,0 m³/h	0 °C ... +60 °C	0 °C ... +50 °C	< 200
SPP-3 15 PC	DN 15	G 1/2 - G 3/4	-	5 - 100	6,0 m³/h	0 °C ... +60 °C	0 °C ... +50 °C	< 200
SPI-1 32	DN 32	G 1 1/2	-	5 - 40	24,3 m³/h	0 °C ... +60 °C	0 °C ... +50 °C	< 200
SPI-2 32	DN 32	G 1 1/2	-	5 - 100	24,3 m³/h	0 °C ... +60 °C	0 °C ... +50 °C	< 200

length

co-ax type	ports	standard	1 limit switch inductive	2 limit switches inductive	1 limit switch mechanical	manual override
SPI 08	thread	Ø 74 mm	-	-	-	-
SPP-1 15 PC	thread	80 mm	-	-	-	-
SPP-2 15 PC	thread	80 mm	-	-	-	-
SPP-3 15 PC	thread	80 mm	-	-	-	-
SPI-1 32	thread	Ø 129 mm	-	-	-	-
SPI-2 32	thread	Ø 129 mm	-	-	-	-

The valve's technical design is based on media and application requirements. This can lead to deviations from the general specifications shown on the data sheet with regards to the design, sealing materials and characteristics.

3/2-way pressure control valve
proportional externally controlled

orifice DN 15
pressure range PN 0 - 100 bar
ports threaded

SPP 15 DR

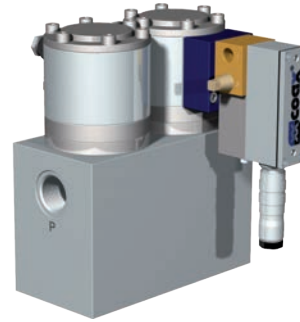
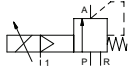

specifications

design	externally controlled, with spring return, switching overlap
function	stepless pressure regulation via control signal
body materials	aluminium
seal materials	EPDM, PU, HNBR, FPM
media	gaseous, liquid
control	via 3/2-way proportional valve / 0 - 10 V
actuator ports	G 1/8
nominal voltage	DC 24 V
electrical connection pilot valve	plug with 7 contacts
enclosure protection	IP 65
energized duty rating	ED 100 %
options / accessories	valve body, approvals, mounting, transmitter of set point value

technical data

co-ax type	orifice [mm]	ports threaded	ports flanged	pressure regulation range [bar]	Kv value max.	media temperature	ambient temperature	operating time [ms]
SPP-1 15 DR	DN 15	G 3/4	-	5 - 40	6,0 m³/h	0 °C ... +60 °C	0 °C ... +50 °C	< 200
SPP-2 15 DR	DN 15	G 3/4	-	5 - 100	6,0 m³/h	0 °C ... +60 °C	0 °C ... +50 °C	< 200

length

co-ax type	ports	standard	1 limit switch inductive	2 limit switches inductive	1 limit switch mechanical	manual override
SPP-1 15 DR	thread	165 mm	-	-	-	-
SPP-2 15 DR	thread	165 mm	-	-	-	-



control

The valve's technical design is based on media and application requirements. This can lead to deviations from the general specifications shown on the data sheet with regards to the design, sealing materials and characteristics.

series RMQ control valves

positioning
 direct actuated
 orifice DN 1 - 32
 pressure range PN 0 - 64 bar
 ports threaded



RMQ

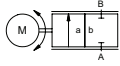

specifications

design	direct actuated with integrated 3-point-regulation
function	stepless stroke regulation via control signal
body materials	aluminium, brass, stainless steel
seal materials	PU, HNBR, FPM, PTFE
media	gaseous, liquid, highly viscous
control signals	I _E 0-20 mA / 4-20 mA U _E 0 - 10 V
nominal voltage	AC / DC 24 V
electrical connection	concentric socket acc. DIN 40040 with 5 contacts, M12x1
enclosure protection	IP 65
energized duty rating	ED 100 % (after release from manufacturer)
options / accessories	approvals, mounting, actual value output

technical data

co-ax type	orifice [mm]	ports threaded	ports flanged	pressure regulation range [bar]	Kv value A ⇌ B	media temperature	ambient temperature	operating time [s]
RMQ 10	DN 1	G 3/8	-	0 - 25	0,8 l/min	0 °C ... +80 °C	0 °C ... +70 °C	3,5
RMQ 10	DN 2	G 3/8	-	0 - 25	1,8 l/min	0 °C ... +80 °C	0 °C ... +70 °C	5,0
RMQ 10	DN 3	G 3/8	-	0 - 25	3,5 l/min	0 °C ... +80 °C	0 °C ... +70 °C	5,0
RMQ 10	DN 4	G 3/8	-	0 - 25	5,7 l/min	0 °C ... +80 °C	0 °C ... +70 °C	7,0
RMQ 10	DN 5	G 3/8	-	0 - 25	9,0 l/min	0 °C ... +80 °C	0 °C ... +70 °C	8,5
RMQ 10	DN 6	G 3/8	-	0 - 25	15,0 l/min	0 °C ... +80 °C	0 °C ... +70 °C	12,0
RMQ 10	DN 8	G 3/8	-	0 - 25	26,0 l/min	0 °C ... +80 °C	0 °C ... +70 °C	16,0
RMQ 10	DN 10	G 3/8	-	0 - 25	45,0 l/min	0 °C ... +80 °C	0 °C ... +70 °C	7,5
RMQ 15	DN 15	G 1/2 - G 3/4	-	0 - 25	5,9 m³/h	0 °C ... +80 °C	0 °C ... +70 °C	13,0
RMQ 20	DN 20	G 3/4 - G 1	-	0 - 16 / 64	7,3 m³/h	-20 °C ... +80 °C	0 °C ... +70 °C	3,0
RMQ 32	DN 32	G 1 1/4 - G 1 1/2	-	0 - 16 / 64	20,0 m³/h	-20 °C ... +80 °C	0 °C ... +70 °C	3,5

length

co-ax type	ports	standard	1 limit switch inductive	2 limit switches inductive	1 limit switch mechanical	manual override
RMQ 10	thread	60 mm	-	-	-	-
RMQ 15	thread	80 mm	-	-	-	-
RMQ 20	thread	217 mm	-	-	-	-
RMQ 32	thread	269 mm	-	-	-	-

2/2-way valve
externally controlled
orifice DN 15 - 100
pressure range PN 0 - 64 bar
ports flanged



special application: hot gas filtration / filter cleaning of coal gasification in coal power stations

special features: - fast opening and closing
- hermetically sealed to the outside
- extremely wear-resistant valve seats

specifications

design	externally controlled, with spring return
function	NC - normally closed / NO - normally open (to DN 50)
body materials	nickel plated steel, stainless steel
seal materials	FPM, graphite, metal bellow (1.4571)
media	gaseous
actuation	pneumatic actuation via 5/2-way pilot valve
vacuum	leak rate < 10 ⁻⁶ mbar•l•s ⁻¹
options / accessories	special flanges, function NO, limit switches, manual override, approvals, special voltage, connector M12x1, pilot valve

technical data

co-ax type	orifice [mm]	ports threaded	ports flanged	pressure range [bar]	Kv value A ⇌ B	media temperature	ambient temperature	switching time [ms] opening / closing
V2	DN 15	-	PN 16 / 40 / 64	0 - 64	7,5 m³/h	-20 °C ... +400 °C	-20 °C ... +60 °C	60 / 60
V2	DN 25	-	PN 16 / 40 / 64	0 - 64	15,0 m³/h	-20 °C ... +400 °C	-20 °C ... +60 °C	60 / 60
V2	DN 40	-	PN 16 / 40 / 64	0 - 64	36,0 m³/h	-20 °C ... +400 °C	-20 °C ... +60 °C	60 / 60
V2	DN 50	-	PN 16 / 40 / 64	0 - 64	46,0 m³/h	-20 °C ... +400 °C	-20 °C ... +60 °C	60 / 60
V2	DN 80	-	PN 16 / 40 / 64 / 100	0 - 64 / 100	200,0 m³/h	-20 °C ... +250 °C	-20 °C ... +60 °C	100 / 100
V2	DN 100	-	PN 16 / 40 / 64 / 100	0 - 64 / 100	220,0 m³/h	-20 °C ... +250 °C	-20 °C ... +60 °C	100 / 100

length

co-ax type	ports	standard	1 limit switch inductive	2 limit switches inductive	1 limit switch mechanical	manual override
V2 DN 15 - 50	flange	140 mm / 140 mm	140 mm / 140 mm	140 mm / 140 mm	-	via pilot valve
V2 DN 80	flange	200 mm / 200 mm	200 mm / 200 mm	200 mm / 200 mm	-	via pilot valve

type LVP 06 special valves

2/2-way valve
externally controlled
orifice DN 6
pressure range PN 0 - 500 bar
ports threaded



special application: gas filling technology, petrochemical process technology

special features: - simple and compact design
- high pressure range up to 500 bar

specifications

design	externally controlled, with spring return
function	NC - normally closed / NO - normally open
body materials	brass
seal materials	EPDM, NBR, FPM
media	gaseous
actuation	pneumatic actuation via 3/2-way pilot valve up to PN 250 bar. > PN 250 bar via 5/2-way pilot valve
vacuum	leak rate < 10 ⁻⁶ mbar•l•s ⁻¹
options / accessories	function NO, limit switches, manual override, approvals, mounting, adapter, pilot valve

technical data

co-ax type	orifice [mm]	ports threaded	ports flanged	pressure range [bar]	Kv value A ⇌ B	media temperature	ambient temperature	switching time [ms] opening / closing
LVP 06	DN 6	G 1/4	-	0 - 500	0,42 m³/h	-20 °C ... +80 °C	-20 °C ... +80 °C	100-3000 / 100-3000

length

co-ax type	ports	standard	1 limit switch inductive	2 limit switches inductive	1 limit switch mechanical	manual override
LVP 06	thread	60 mm	60 mm	60 mm	-	via pilot valve



special

The valve's technical design is based on media and application requirements. This can lead to deviations from the general specifications shown on the data sheet with regards to the design, sealing materials and characteristics.

type PCB-1 10 special valves

2/2-way valve

externally controlled

orifice DN 10

pressure range PN 0 - 25 bar

ports threaded



special application: glue application and bonding, coolant supply on machine tools up to 25 bar

special features: - hermetically sealed to the outside
- wear-resistant valve seats
- can be mounted in a block

specifications

design	externally controlled, with spring return
function	NC - normally closed / NO - normally open
body materials	aluminium, stainless steel
seal materials	EPDM, NBR, FPM, metal bellow (1.4571)
media	gaseous, liquid, highly viscous, gelatinous, pasty, contaminated
actuation	pneumatic actuation via 5/2-way pilot valve
vacuum	leak rate <math> < 10^{-6} \text{ mbar} \cdot \text{l} \cdot \text{s}^{-1}</math>
options / accessories	special threads, function NO, leak ports, limit switches, manual override, approvals, special voltage, pilot valve

technical data

co-ax type	orifice [mm]	ports threaded	ports flanged	pressure range [bar]	Kv value A ⇌ B	media temperature	ambient temperature	switching time [ms] opening / closing
PCB-1 10	DN 10	G 3/8	-	0 - 25	3,0 m³/h	-20 °C ... +150 °C	-20 °C ... +150 °C	30-3000 / 30-3000

length

co-ax type	ports	standard	1 limit switch inductive	2 limit switches inductive	1 limit switch mechanical	manual override
PCB-1 10	thread	60 mm	60 mm	60 mm	-	via pilot valve

type PLB 05 special valves

2/2-way valve

externally controlled

orifice DN 5

pressure range PN 0 - 25 bar

ports threaded



special application: glue laminated timber, glue laminated beam, bonding technology

special features: - hermetically sealed to the outside
- wear-resistant valve seats
- can be mounted in a block

specifications

design	externally controlled, with spring return
function	NC - normally closed
body materials	aluminium, stainless steel
seal materials	EPDM, NBR, FPM, metal bellow (1.4571)
media	liquid, pasty
actuation	pneumatic actuation via 5/2-way pilot valve
vacuum	low vacuum
options / accessories	pilot valve

technical data

co-ax type	orifice [mm]	ports threaded	ports flanged	pressure range [bar]	Kv value A ⇌ B	media temperature	ambient temperature	switching time [ms] opening / closing
PLB 05	DN 5	G 1/4 - G 3/8	-	0 - 25	1,08 m³/h	-20 °C ... +60 °C	-20 °C ... +60 °C	50 / 50

length

co-ax type	ports	standard	1 limit switch inductive	2 limit switches inductive	1 limit switch mechanical	manual override
PLB 05	thread	124 mm	-	-	-	-

The valve's technical design is based on media and application requirements. This can lead to deviations from the general specifications shown on the data sheet with regards to the design, sealing materials and characteristics.

3/2-way valve
 direct actuated
 orifice DN 10
 pressure range vacuum
 ports threaded



special application: vacuum engineering
special features: - pulse acting
 - bi-stable
 - insensitive to dirt

specifications

design	pulse acting
body materials	aluminium
seal materials	NBR
media	gaseous
actuation	DC direct-current magnet
nominal voltage	DC 24 V
vacuum	leak rate < 10 ⁻⁶ mbar•l•s ⁻¹
options / accessories	

technical data

co-ax type	orifice [mm]	ports threaded	ports flanged	pressure range [bar]	Kv value A ⇌ B	media temperature	ambient temperature	switching time [ms] opening / closing
IV 10-3	DN 10	G 1/2	-	vacuum max. 98%	-	-5 °C ... +60 °C	-5 °C ... +60 °C	30 / 30

length

co-ax type	ports	standard	1 limit switch inductive	2 limit switches inductive	1 limit switch mechanical	manual override
IV 10-3	thread	142 mm	-	-	-	-

type IV 16-3 special valves

3/2-way valve
 direct actuated
 orifice DN 20 - 32
 pressure range vacuum
 ports threaded

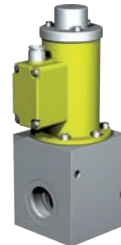

special application: vacuum engineering
special features: - pulse acting
 - bi-stable
 - insensitive to dirt

specifications

design	pulse acting
body materials	aluminium
seal materials	NBR
media	gaseous
actuation	DC direct-current magnet
nominal voltage	DC 24 V
vacuum	leak rate < 10 ⁻⁶ mbar•l•s ⁻¹
options / accessories	

technical data

co-ax type	orifice [mm]	ports threaded	ports flanged	pressure range [bar]	Kv value A ⇌ B	media temperature	ambient temperature	switching time [ms] opening / closing
IV 16-3	DN 20	G 3/4	-	vacuum max. 98%	-	-5 °C ... +60 °C	-5 °C ... +60 °C	80 / 80
IV 16-3	DN 25	G 1	-	vacuum max. 98%	-	-5 °C ... +60 °C	-5 °C ... +60 °C	80 / 80
IV 16-3	DN 32	G 1 1/4 - G 1 1/2	-	vacuum max. 98%	-	-5 °C ... +60 °C	-5 °C ... +60 °C	80 / 80

length

co-ax type	ports	standard	1 limit switch inductive	2 limit switches inductive	1 limit switch mechanical	manual override
IV 16-3	thread	273 mm	-	-	-	-



special

The valve's technical design is based on media and application requirements. This can lead to deviations from the general specifications shown on the data sheet with regards to the design, sealing materials and characteristics.

müller co-ax ag

Gottfried-Müller-Str. 1
74670 Forchtenberg
Germany

Tel: +49 7947 828-0
Fax: +49 7947 828-11

info@co-ax.com
www.co-ax.com

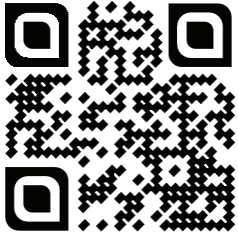

V08/04- 2016_e Technische Änderungen vorbehalten. Subject to modifications.

Alle technischen Angaben entsprechen dem Stand der Drucklegung. Technische Änderungen sind vorbehalten. Auch Irrtümer können wir leider nicht ganz ausschließen. Haben Sie bitte Verständnis dafür, dass aus den Angaben, Abbildungen und Beschreibungen keine juristischen Ansprüche hergeleitet werden können. Die in dieser Publikation enthaltenen Texte, Fotos, technische Zeichnungen und jegliche weitere Form der Darstellungen sind geschütztes Eigentum der müller co-ax ag. Jede Weiterverwendung bedarf der ausdrücklichen Zustimmung der müller co-ax ag. All technical information is up to date at the time of going to press. We reserve the right to make technical changes. Unfortunately, we cannot exclude the possibility that errors have been made. Please understand that no legal demands can be made derived from the information, images and descriptions. The texts, photos, technical drawings and any other form of representation are trademarked property of müller co-ax ag. Any further usage requires express permission from müller co-ax ag.

• coaxial valves • high pressure
modules • special valves • cartr
• lateral valves • coaxial valves •
valves • manifolds & modules •
ves • high pressure valves • late
al valves • manifolds & modules