

PRODUCT CATALOG 2020

KEOFITT CLASSIC 4KAI



KEOFITT
WORLD LEADERS IN STERILE SAMPLING™

HOW IT WORKS

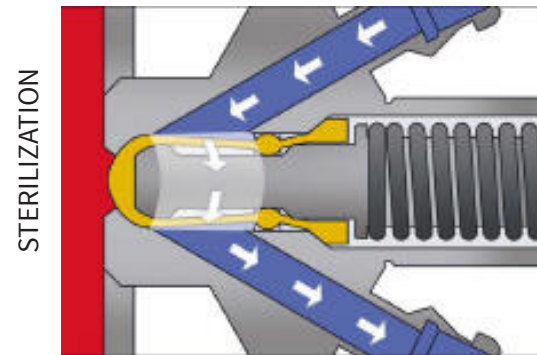
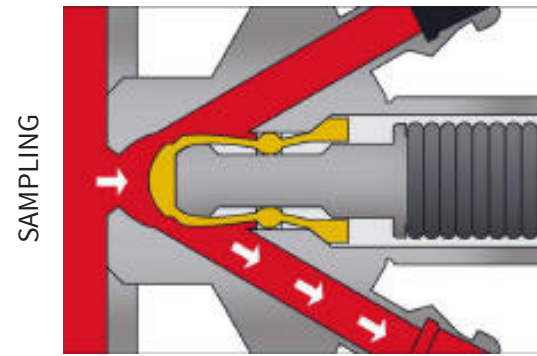

KEOFITT CLASSIC 4KAI SAMPLING VALVE

The KEOFITT CLASSIC 4KAI Sampling Valve is the smallest KEOFITT CLASSIC valve available. It is designed for the sampling of low viscosity products in the range of 0-100 cP with particles less than 1.5 mm in diameter. Sampling of more viscous liquids is possible, only will it take longer (depending on process pressure).

This valve is used in a range of industries such as brewery, dairy, pharmaceutical and bio-tech for products such as:

- Water
- Milk
- Medical solutions
- Filtered Beer
- Perfume
- Olive Oil

Besides the selection of the Valve Body and the Valve Head there are three different membrane materials to choose from: Silicone, EPDM and PTFE.

Accessories include quick couplings for the connection of tubing, piping and more.



KEOFITT CLASSIC 4KAI SAMPLING VALVE - BODIES

4KAI BODIES

HOSE PIECE

WELDING BODIES

TANK WELDING
Ø28

PIPE WELDING 1"



440001



440011

CONNECTION BODIES

MINI CLAMP

CLAMP 1" & 1 1/2"





440021



















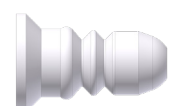







440022









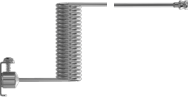

KEOFITT CLASSIC 4KAI SAMPLING VALVE - HEADS

4KAI HEADS	<p>TYPE H TURN KNOB 0-10 BAR (G)</p>
	 <p>440041</p>
	 <p>440041E</p>
<p>PTFE</p>	 <p>445541</p>

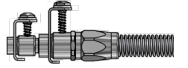
<p>TYPE N PNEUMATIC 0-10 BAR (G)</p>
 <p>440044</p>
 <p>440044E</p>
 <p>445544</p>

KEOFITT CLASSIC 4KAI - PARTS & ACCESSORIES

4KAI™ PARTS & ACCESSORIES	O-RINGS	 800830 10.3X2.4 SILIC	 800830E EPDM 10.3X2.4	 550184 FESTO	 600825 SILICONE 7.1X1.6			
	MEMBRANES	 400051 SILICONE	 400052 EPDM	 400055 PTFE				
	FOR HOSE PIECE	 550057 KÄRCHER ADAPTOR	 800082 QC HOSE BARB 3/8	 800083 QC TC	 800086 QC W9 WITH M4 HP	 800061 QC PLUG	 800070 QC STEEL PIPE	
		 600062 RUBBER CAP						
	FOR VALVE HEADS	 900018 TOMMY BAR	 600370 LEVER HANDLE SELF-CLOSING	 600170 LEVER HANDLE Q/N	 400255 TOOL PTFE			
	MISC.	 440064 DOUBLE ST. ST. CHAIN	 900086 CLAMP RING 1"	 900075 CLAMP RING 1/2"	 900047 TUBE PTFE 10/8	 900087 GASKET 1/2"	 900091 GASKET EPDM 1"	

 900045 QC SYRINGE INJECTION	 900031 HP MALE THREAD M12	 800058 COIL	 800059 XL COIL	 800091 QC PTFE	 550003 PTFE QC 1.0M	 550002 PTFE QC 0.5M	
 550002.2 PTFE QC/TC 0.5M	 550003.2 PTFE QC/TC 1.0M	 440149 BUSHING FOR 4KAI/ BASIX HEAD	 800052 HOSE PIECE/ HOSE PIECE				