

KEOFITT CLASSIC W15 SAMPLING VALVE

The KEOFITT CLASSIC W15 Sampling Valve is designed for high viscosity products in the range of 0-50,000 cP with particles up to 8 mm in diameter.



This valve is used in a range of industries such as brewery, dairy, pharmaceutical and bio-tech for products such as:

- Yoghurt
- Honey
- Syrup
- Ketchup
- Marmalade
- Creams and lotions
- Fruit pulp products

Available with PTFE membrane.



KEOFITT CLASSIC W15 SAMPLING VALVE - BODIES

		WELDING BODIES	
		TANK WELDING	PIPE WELDING
W15 BODIES	MINI TRI-CLAMP	 <p>860001</p>	 <p>860011</p>
	WELDING ENDS	 <p>860007</p>	<p><i>On request</i></p>

CONNECTION BODIES		
VARIVENT Ø68	CLAMP 2"	CLAMP 3"
 <p>860009</p>	 <p>860002</p>	 <p>860003</p>
<p><i>On request</i></p>	<p><i>On request</i></p>	<p><i>On request</i></p>











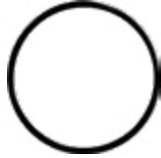

KEOFITT CLASSIC W15 SAMPLING VALVE - HEADS

W15 HEADS		TYPE H TURN KNOB 0-6 BAR (G)	TYPE B NO SPRING 0-12 BAR (G)
	PTFE	 865541	 865547



	TYPE N PNEUMATIC 0-6 BAR (G)
	 865544

KEOFITT CLASSIC W15 - PARTS & ACCESSORIES

W15™ PARTS & ACCESSORIES	O-RINGS	 400208 EPDM 60X3	 550184 FESTO	 900074 GASKET EPDM 3/4"
	MEMBRANES	 860055 PTFE		
	FOR MINI TRI-CLAMP	 300021 CLAMP PTFE 10/8	 550004 PTFE TC 0.5M	 550005 PTFE TC 1.0M
	FOR VALVE HEADS	 600170 LEVER HANDLE Q/N	 600370 LEVER HANDLE SELF-CLOSING	 860255 TOOL PTFE
	MISC.	 900075 CLAMP RING 1/2"	 900091 GASKET EPDM 1"	 900092 GASKET EPDM 2"

 800014 ADAPTER TC/1"	 900013 MINI CLAMP SPIKE	 900096 ADAPTER HP/TC
 900093 GASKET EPDM 3"	 900186 CLAMP RING	